



GANDHI SCHOOL OF
ENGINEERING, BHABANDHA, BERHAMPUR

TEACHING AND LEARNING MATERIAL

**SUBJECT: ADVANCE COMMUNICATION
ENGINEERING
SEMESTER: 6TH**

Unit-1:

RADAR & NAVIGATION AIDS

RADAR KIT

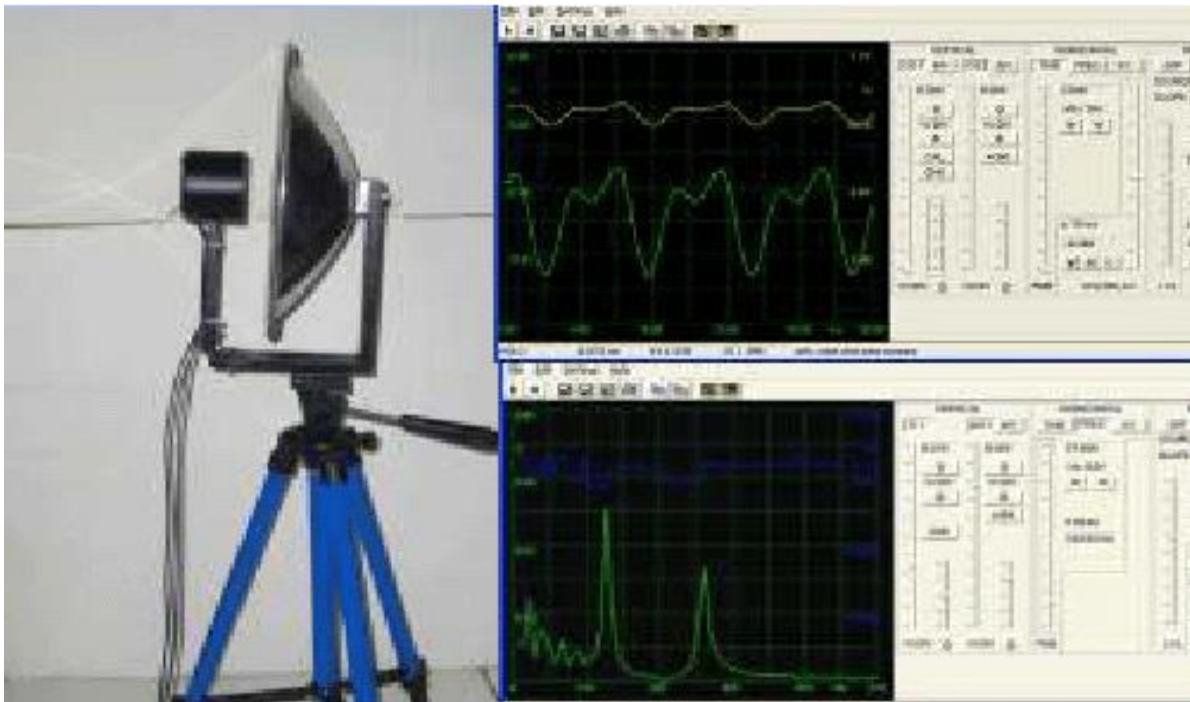

PULSED RADAR SYSTEM.

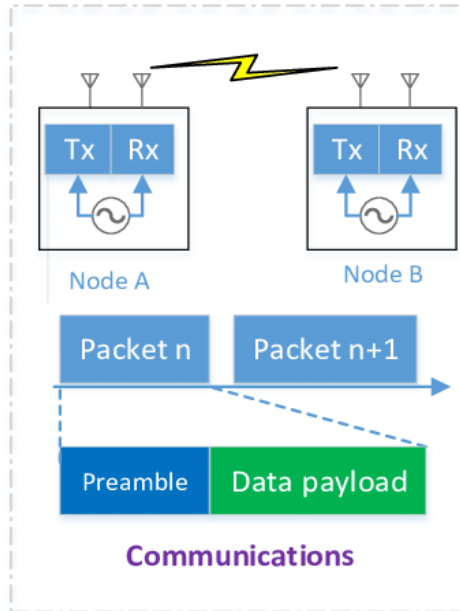
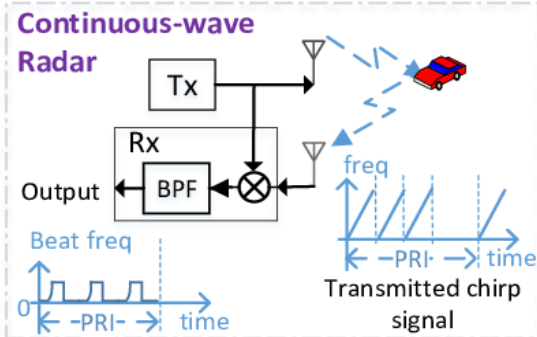
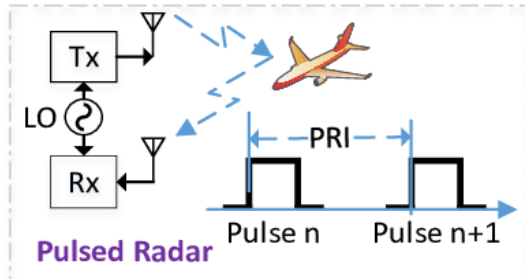

MTI RADAR

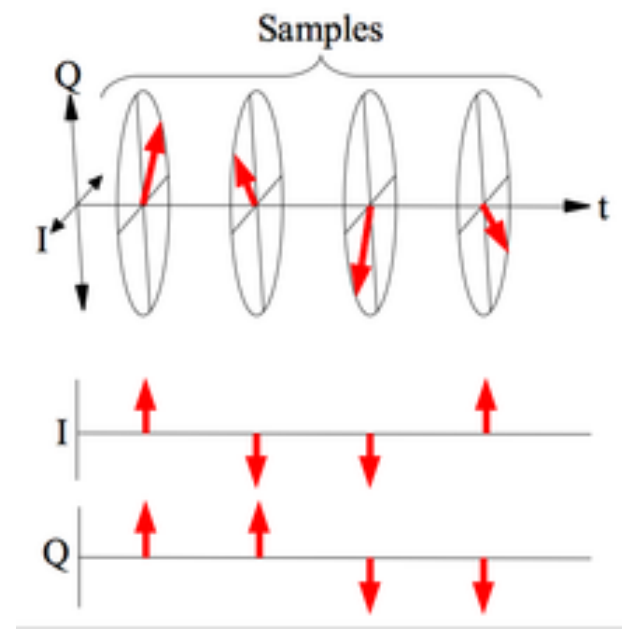
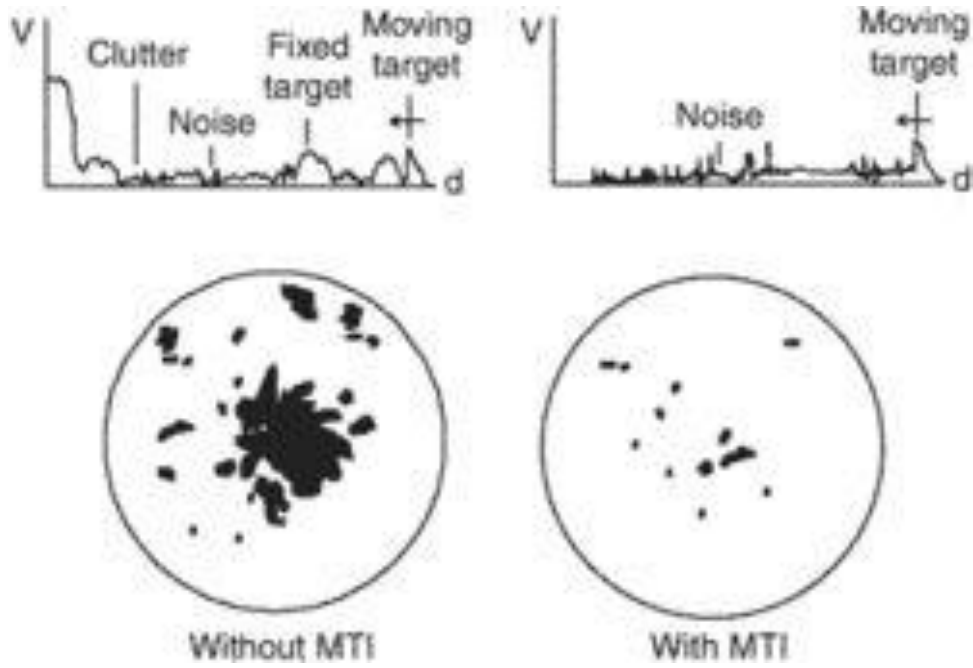

Unit-2: SATELLITE COMMUNICATION



SATELLITE ORBITS

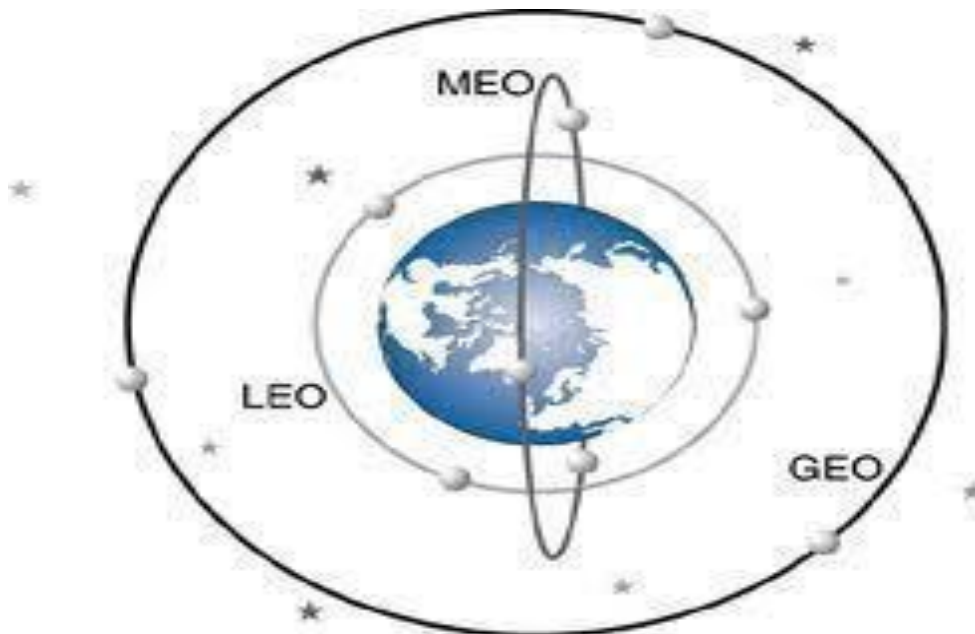

UPLINK & DOWNLINK SYSTEM

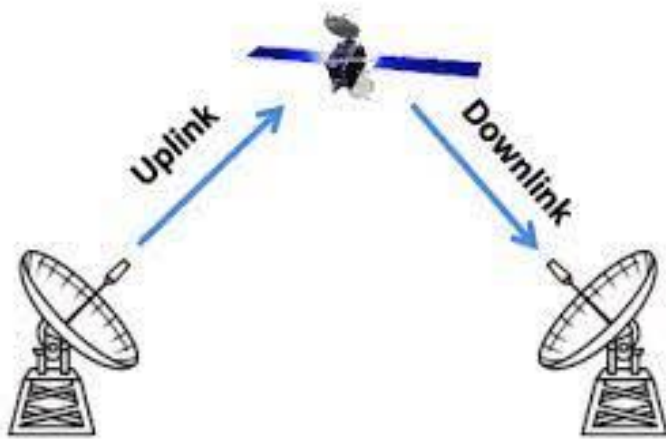

DIRECT BROADCAST SYSTEM (DBS)

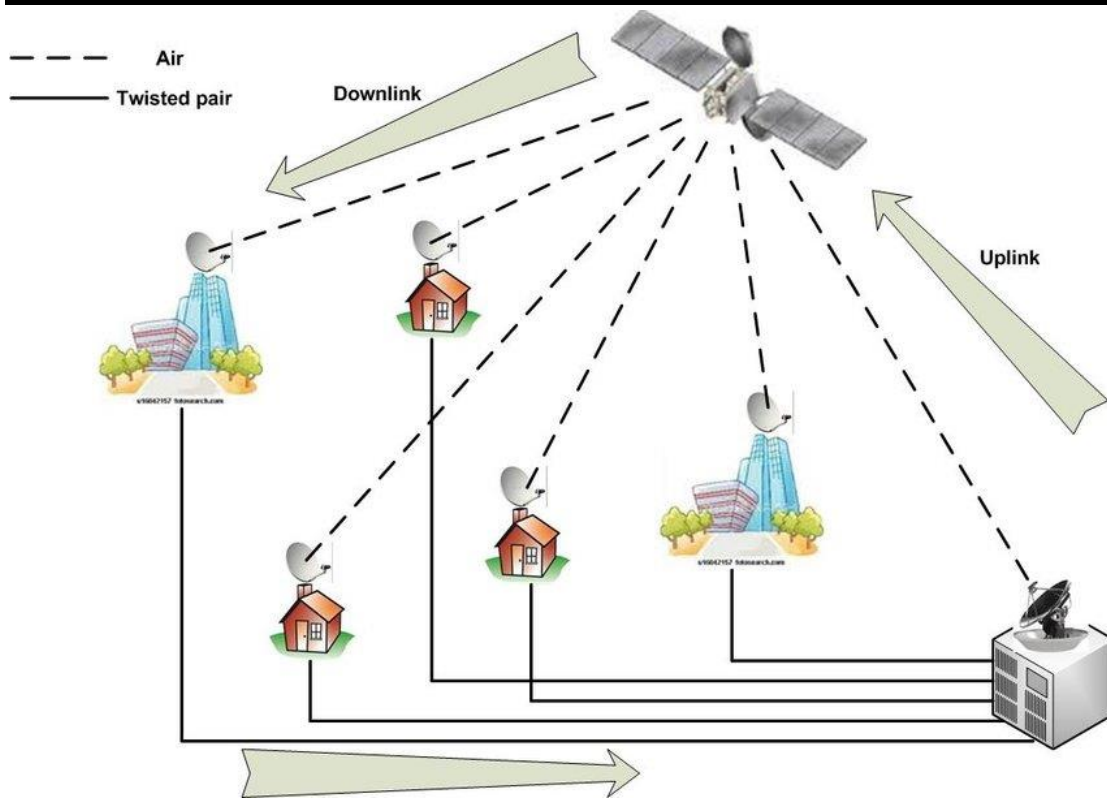

VSAT

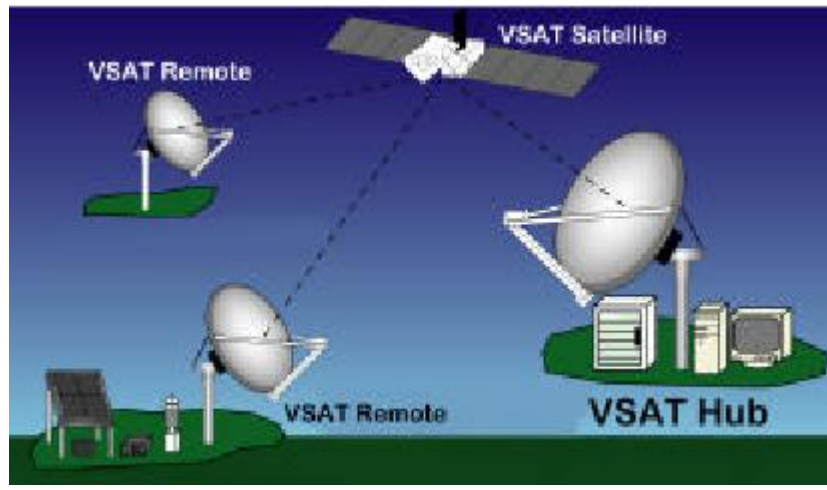

MULTIPLE ACCESSING

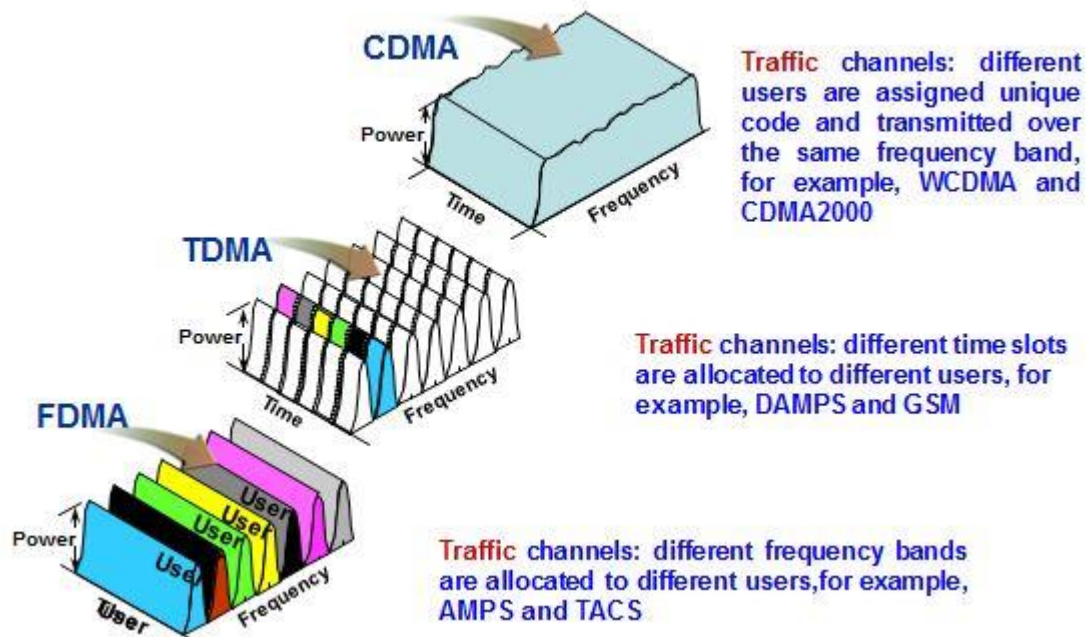

GPS

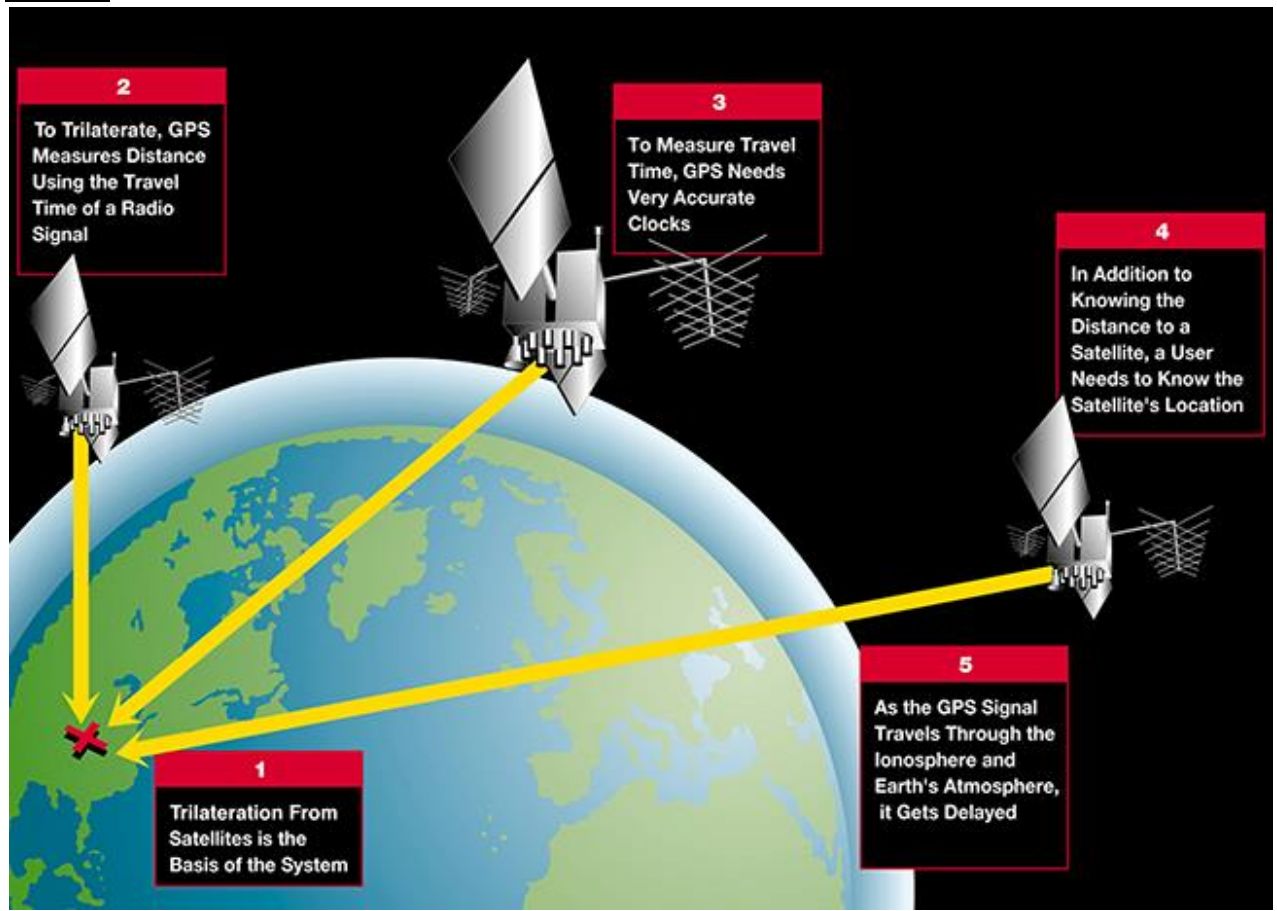

UNIT-3: OPTICAL FIBER COMMUNICATION

OPTICAL FIBER

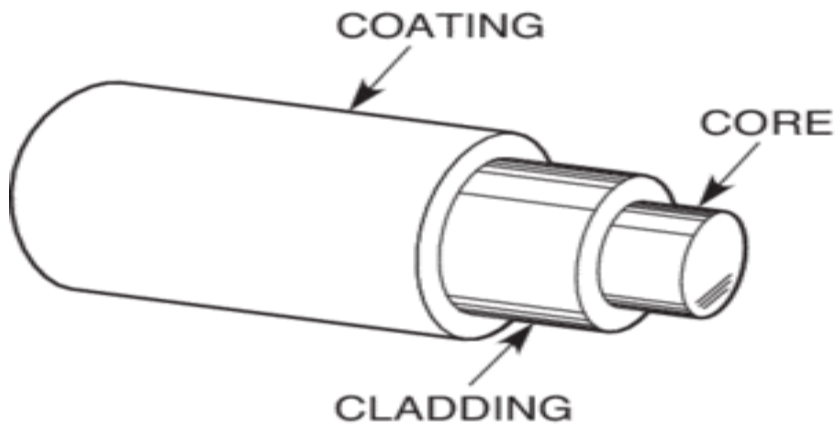

LASER DIODE

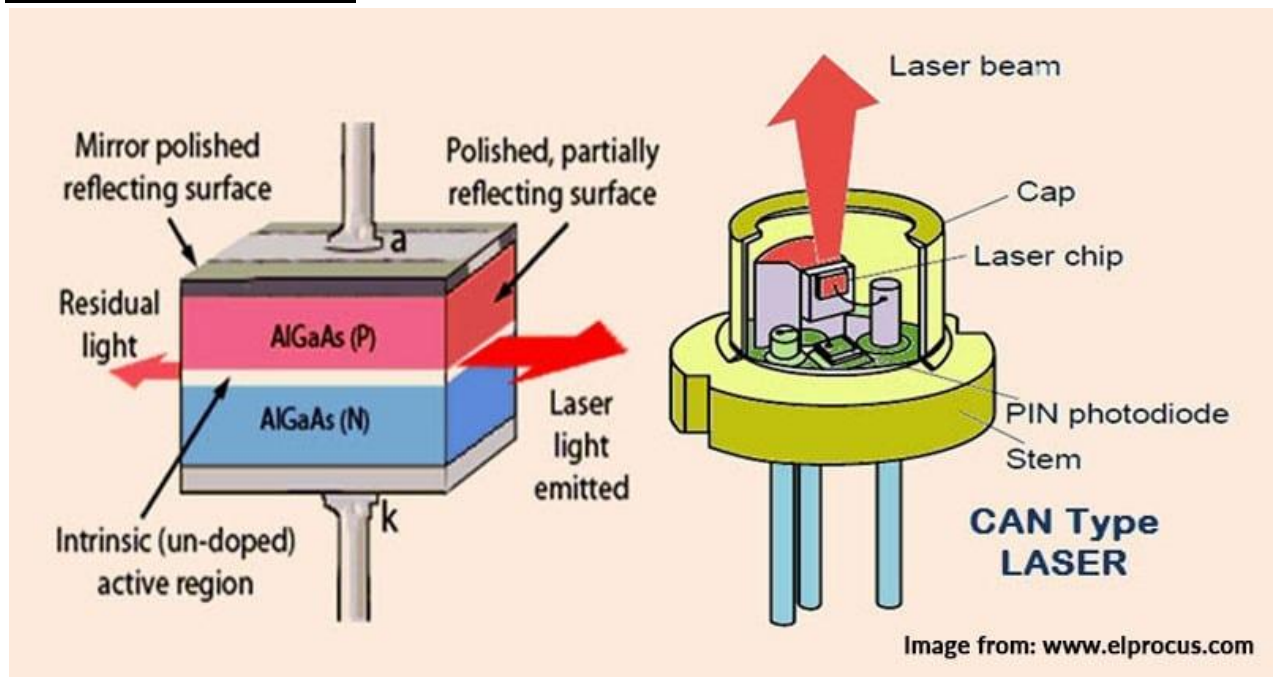

APD DIODES

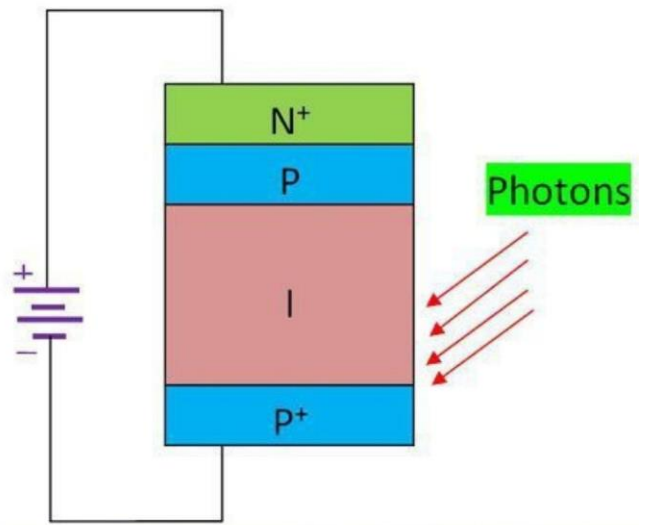
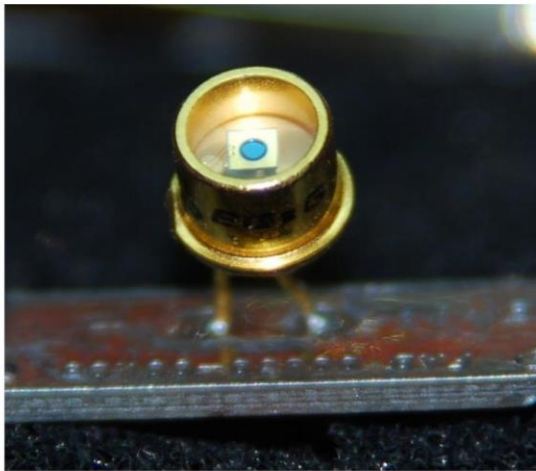

Structure of Avalanche Photodiode

UNIT-4 TELECOMMUNICATION SYSTEM

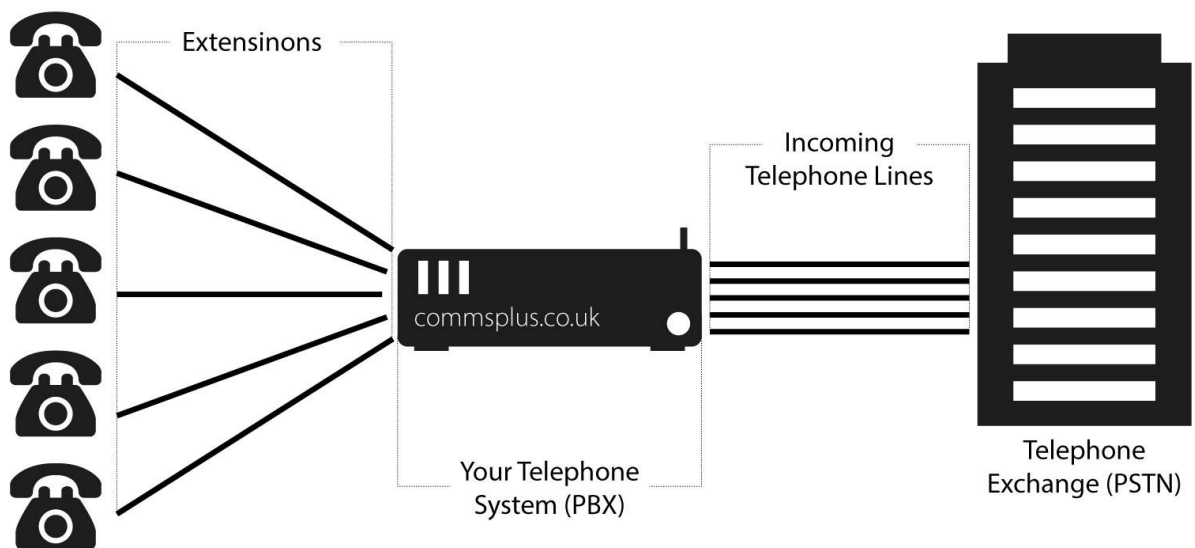

UNIT-5 DATA COMMUNICATION

MODEM



UNIT-6 WIRELESS COMMUNICATION

Smartphone hardware architecture

