



**GANDHI SCHOOL OF  
ENGINEERING, BHABANDHA, BERHAMPUR**

**SUBJECT: POWER ELECTRONICS AND  
PLC  
SEMESTER:5TH**

**PREPARED BY:ER. SATYA TRIPATHY**

# CHAPTER-1: UNDERSTAND THE CONSTRUCTION AND WORKING OF POWER ELECTRONIC DEVICES

## IGBT Operation Area

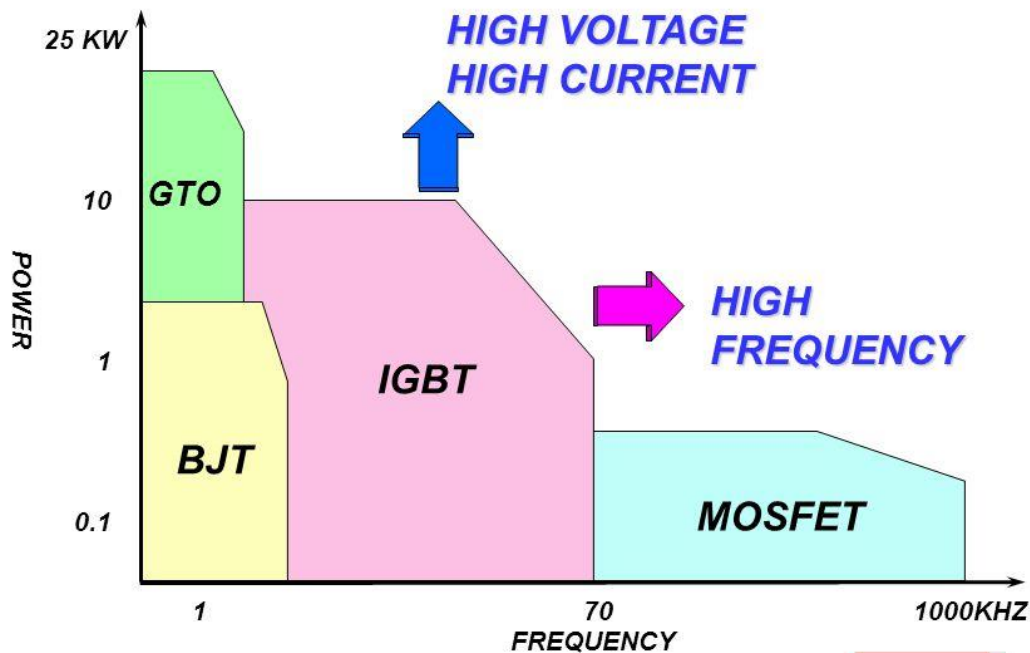

## GATE TURN-OFF THYRISTOR

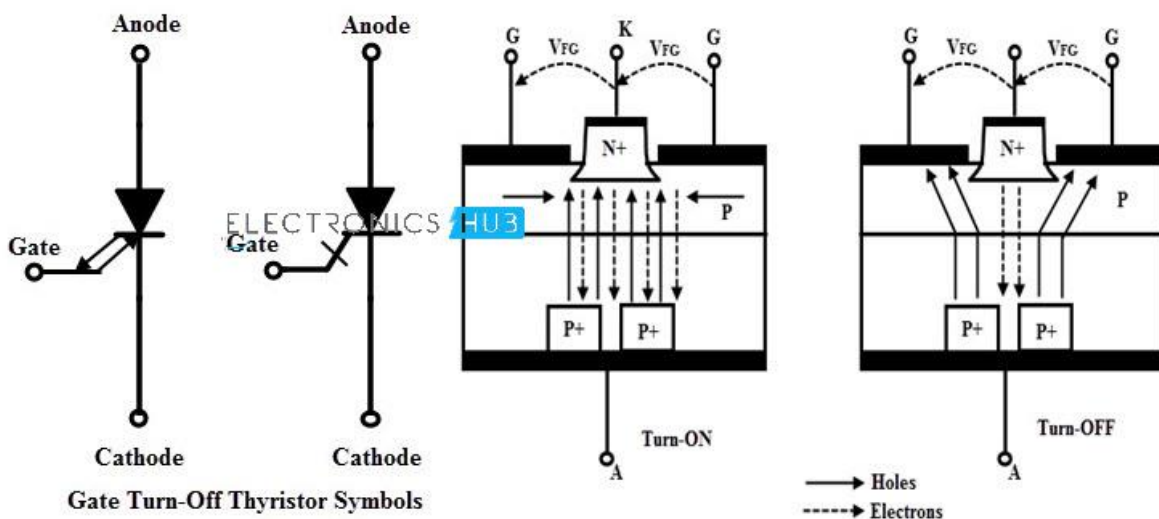

# Difference Between SCR, TRIAC, DIAC

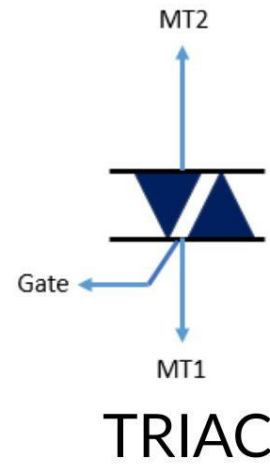
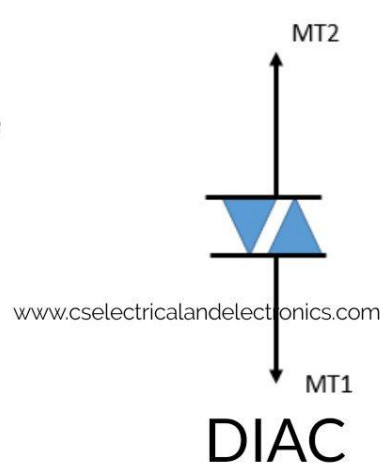
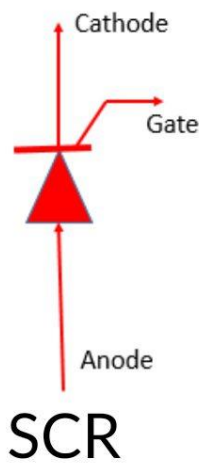

CHAPTER-2: UNDERSTAND THE WORKING OF CONVERTERS, AC REGULATORS AND CHOPPERS.

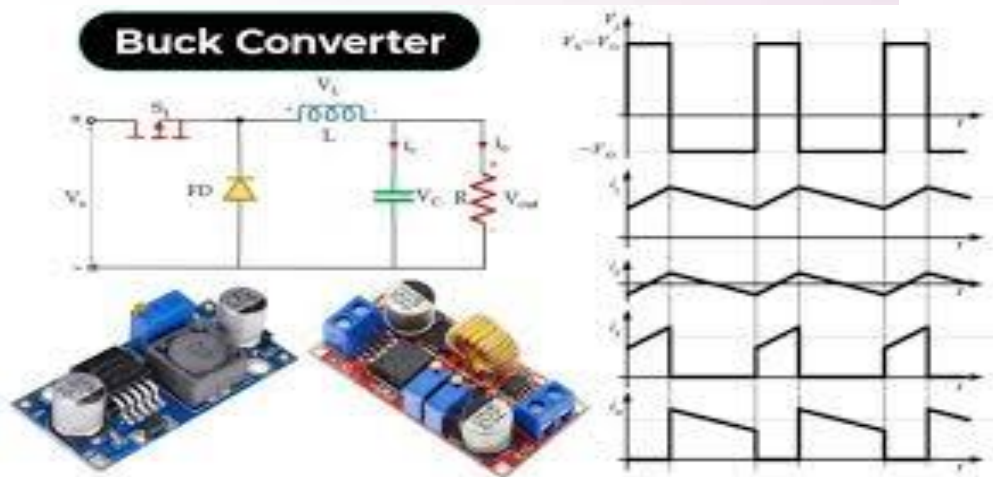

# CHAPTER-3: UNDERSTAND THE INVERTERS AND CYCLO-CONVERTERS

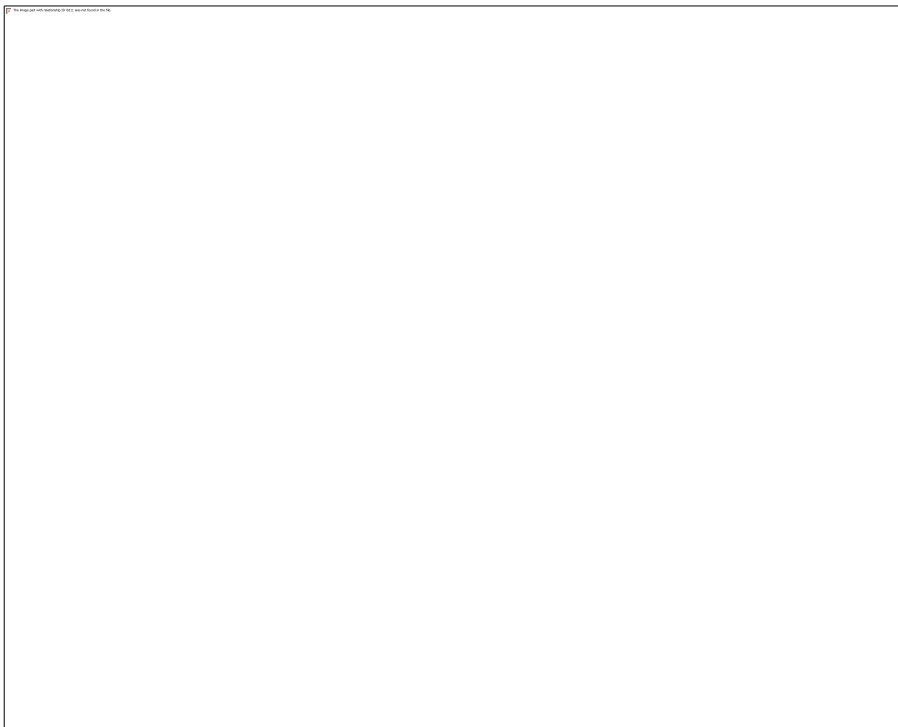

## CHAPTER-4: UNDERSTAND APPLICATIONS OF POWER ELECTRONIC CIRCUITS



[www.cselectricalandelectronics.com](http://www.cselectricalandelectronics.com)



SMPS - Switched Mode Power Supply

# CHAPTER-5:PLC AND ITS APPLICATIONS

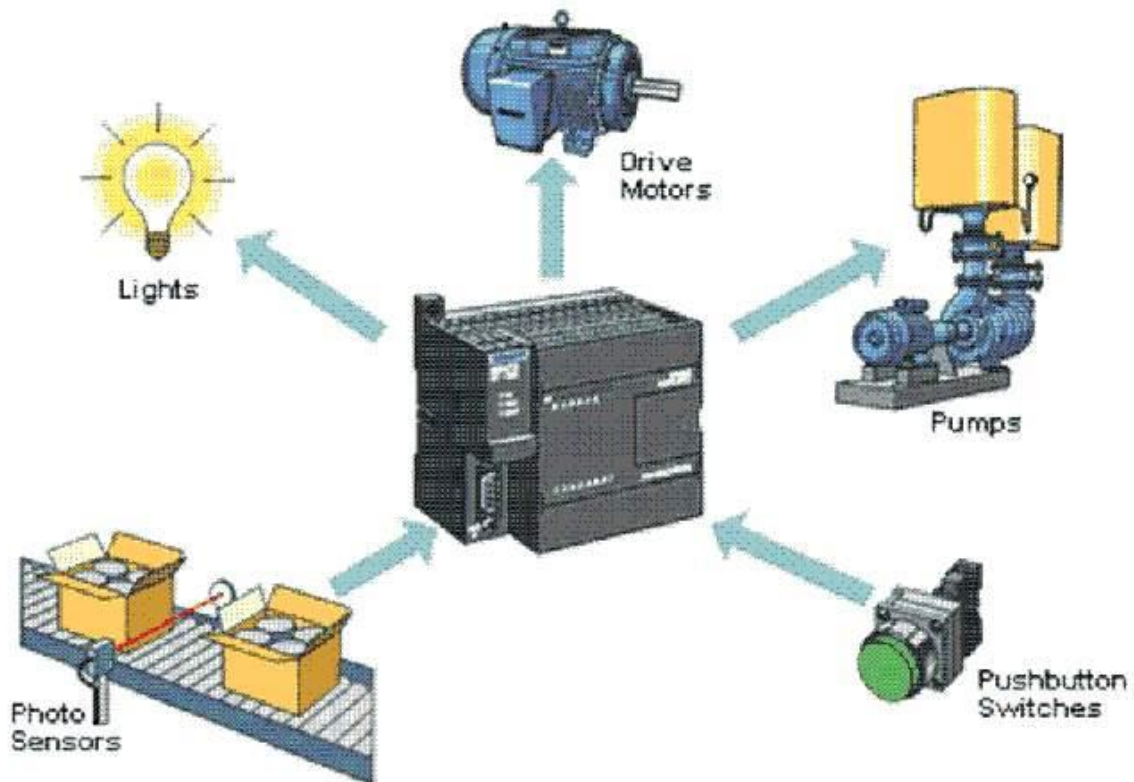
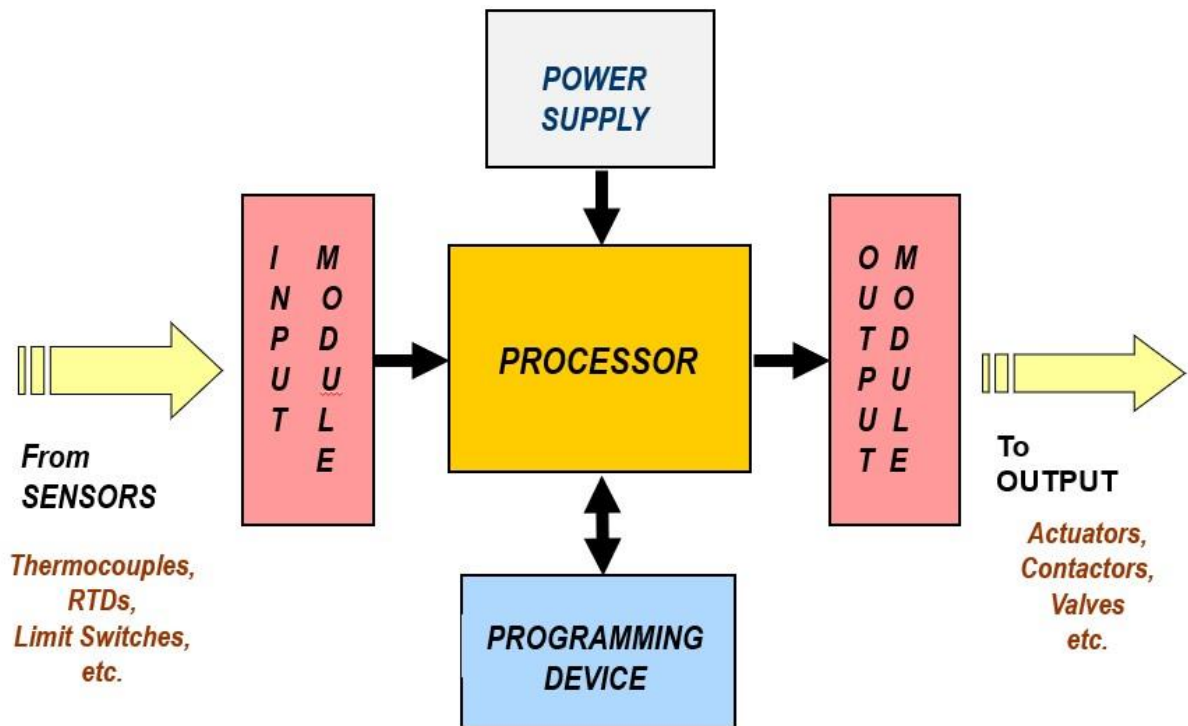



WHAT IS A



# Programmable Logic Controller (PLC)?