

BRANCH: MECHANICAL ENGINEERING

SEMESTER: 5TH

SUBJECT: MECHATRONICS

FACULTIES: Er. SUNIL KUMAR SAHU

Er. MANASI BHOI

Er. BEDA PRAKASH NAYAK



Unit 1: INTRODUCTION TO MECHATRONICS

1.1 Definition of Mechatronics

The synergistic combination of precision mechanical engineering, electronic control and systems thinking in the design of products and manufacturing processes.

"Mechatronics" involves a number of technologies such as:

- Mechanical engineering;
- Electronic engineering;
- Electrical engineering;
- Computer technology;
- Control engineering

1.2 Advantages and Disadvantages of Mechatronics

Following are the advantages and disadvantages of mechatronics:

Advantages:

1. The products produced are cost effective and of very good quality.
2. The performance characteristics of mechatronics products are such which are otherwise very difficult to achieve without the synergistic combination.
3. High degree of flexibility.
4. A mechatronics product can be better than just sum of its parts.
5. Greater extent of machine utilization.
6. Due to the integration of sensors and control systems in a complex system, capital expenses are reduced
7. Owing to the incorporation of intelligent, self-correcting sensory and feedback systems, the mechatronic approach results in:
 - Greater productivity;
 - Higher quantity and producing reliability.

Disadvantages:

1. High initial cost of the system.
2. Imperative to have knowledge of different engineering fields for design and implementation.
3. Specific problems for various systems will have to be addressed separately and properly.
4. It is expensive to incorporate mechatronics approach to an existing/old system.

1.3 Application of Mechatronics

Following are the examples of mechatronics systems:

1. Home appliances:

- Washing machines
- Bread machines etc.

2. Automobile:

- Electrical fuel injection
- Antilock brake system.

3. Aircraft:

- Flight control
- Navigation system.

1. Automated manufacturing:

- Robots
- Numerically controlled (NC) machine tools.

1.4 Scope of Mechatronics in Industrial Sector

Mechatronics helps in designing and maintaining automated equipment. Technicians and engineers work in laboratories, offices or on-site manufacturing plants. The goal is to produce safe and efficient automated equipment. Technicians primarily maintain machinery, while engineers are more concerned with design and development of components and products.

A Mechatronics engineer unites the principles of engineering disciplines like mechanics, electronics, and computing to generate a simpler, more economical and reliable system the process of mechatronics engineering involves designing, assembling, testing, and evaluating components and products.

Mechatronics technicians apply their knowledge of engineering to solve technical problems and maintain automated mechanical equipment. A job of a mechatronics technician includes inspecting, troubleshooting and repairing electrical and electronic components.

1.5 Components of a mechatronic system:

- Actuators
- Sensors
- Input signal conditioning & interfacing
- Digital control architectures
- Output signal conditioning & interfacing
- Graphical displays

1. Actuators: Solenoids, voice coils; D.C. motors; Stepper motors; Servomotor; hydraulics; pneumatics.

2. Sensors: Switches; Potentiometer; Photoelectric; Digital encoder; Strain gauge; Thermocouple; accelerometer etc.

3. Input signal conditioning and interfacing: Discrete circuits; Amplifiers, Filters; A/D, D/D.
4. Digital control architectures: Logic circuits; Microcontroller; SBC; PLC; Sequencing and timing; Logic and arithmetic; Control algorithms; Communication.
5. Output signal conditioning and interfacing: Amplifiers; PWM; Power transistors.
6. Graphical displays: LEDs; Digital displays; LCD; CRT.

- The actuators produce motion or cause some action;
- The sensors detect the state of the system parameters, inputs and outputs;
- Digital devices control the system;
- Conditioning and interfacing circuits provide connection between the control circuit and the input/output devices;
- Graphical displays provide visual feedback to users.

1.6 Importance of Mechatronics in automation

Today's customers are demanding more variety and higher levels of flexibility in the products. Due to these demands and competition in the market, manufacturers are thriving to launch new/modified products to survive. It is reducing the product life as well as lead-time to manufacture a product. It is therefore essential to automate the manufacturing and assembly operations of a product.

Mechatronics concurrently employs the disciplines of mechanical, electrical, control and computer engineering at the stage of design itself. Mechanical discipline is employed in terms of various machines and mechanisms, whereas electrical engineering as various electric prime movers viz. AC/DC, servo motors and other systems is used. Control engineering helps in the development of various electronics-based control systems to enhance or replace the mechanics of the mechanical systems. Computers are widely used to write various softwares to control the control systems; product design and development activities; materials and manufacturing resource planning, record keeping, market survey, and other sales related activities.

Using computer aided design (CAD) / computer aided analysis (CAE) tools, three-dimensional models of products can easily be developed. These models can then be analyzed and can be simulated to study their performances using numerical tools. These numerical tools are being continuously updated or enriched with the real-life performances of the similar kind of products. These exercises provide an approximate idea about performance of the product/system to the design team at the early stage of the product development. Based on the simulation studies, the designs can be modified to achieve better performances.

During the conventional design manufacturing process, the design assessment is generally carried out after the production of first lot of the products. This consumes a lot of time, which leads to longer (in months/years) product development lead-time. Use of CAD-CAE tools saves significant time in comparison with that required in the conventional sequential design process. CAD-CAE generated final designs are then sent to the production and process planning section.

Mechatronics based systems such as computer aided manufacturing (CAM): automatic process planning, automatic part programming, manufacturing resource planning, etc. uses the design data provided by the design team. Based these inputs, various activities will then be planned to achieve the manufacturing targets in terms of quality and quantity with in a stipulated time frame.

Mechatronics based automated systems such as automatic inspection and quality assurance, automatic packaging, record making, and automatic dispatch help to expedite the entire manufacturing operation. These systems certainly ensure a supply better quality, well packed and reliable products in the market.

Automation in the machine tools has reduced the human intervention in the machining operation and improved the process efficiency and product quality. Therefore, it is important to study the principles of mechatronics and to learn how to apply them in the automation of a manufacturing system.

Unit 2: SENSORS AND TRANSDUCERS

2.1 Definition of Transducers

It is defined as an element when subjected to some physical change experiences a related change or an element which converts a specified measure and into a usable output.

It can also be defined as a device that converts a signal from one form of energy to another form.

Most of the transducers either convert electrical energy into mechanical displacement and/or convert some non-electrical physical quantity (e.g., force, sound, temperature etc.) to an electrical signal.

A transducer performs the following functions:

1. Detects or senses the presence, magnitude and changes in physical quantity being measured.
2. Provides a proportional electrical output signal.

A transducer can be broadly defined as a device which converts a non-electrical quantity into an electrical quantity.

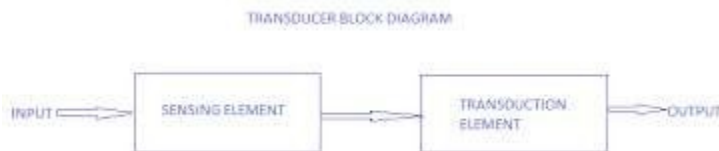

2.2 Classification of Transducers

Inverse transducer

An inverse transducer is defined as a device which converts an electrical quantity into a non-electrical quantity.

A piezoelectric crystal acts as an inverse transducer because when a voltage is applied across its surfaces, it changes its dimensions causing a mechanical displacement.

Active transducers

They are also known as self-generating type transducers. These transducers develop their own voltage or current. The energy required for production of an output signal is obtained from the physical phenomenon being measured.

Examples: Thermocouples and thermopiles, piezoelectric pick-up, photovoltaic cell.

Passive transducers

They are known as externally-powered transducer. These transducers derive the power required for the energy conversion from an external power source. However, they may absorb some energy from the physical phenomenon under study.

Examples: Resistance thermometers and thermistors, potentiometric devices, differential transformer, photoemission cell etc.

Analogue transducers

These transducers convert the input physical phenomenon into an analogous output which is a continuous function of time.

Examples: Strain gauge, a thermocouple, a thermistor or an LVDT (linear voltage differential transformer).

Digital transducers

These transducers convert the input physical phenomenon into an electrical output which may be in form of pulse'

Classification based on electrical principle involved:

1. Variable-resistance type:

- Strain and pressure gauges.
- Thermistors, resistance thermometers'
- Photoconductive cell etc.

2. Variable-inductance type:

- Linear voltage differential transformer (LVDT).
- Reluctance pick-up.
- Eddy current gauge.

3. Variable-capacitance type:

- Capacitor microphone.
- Pressure gauge.
- Dielectric gauge.

4. Voltage-generating type:

- Thermocouple.
- Photovoltaic cell.
- Rotational motion tachometer'
- Piezoelectric pick-up.

5. Voltage-divider type:

- Potentiometer position censor'
- Pressure-actuated voltage divider.

2.3 Electromechanical Transducers

Any type of device that either converts an electrical signal into sound waves (as in a loudspeaker) or converts a sound wave into an electrical signal (as in the microphone).

Advantages:

1. Less power consumption
2. Friction effect is minimum
3. More compact instrumentation
4. Possibility of non-contact measurements
5. Good frequency

2.4 Transducers actuating mechanisms

Actuating mechanism converts a source of energy, which can be mechanical force, electrical current, hydraulic fluid pressure or pneumatic pressure etc. into motion.

An actuating mechanism not only changes the state of the object being controlled but also moves the controlled member with the minimum possible deviations.

Eg. corrugated diaphragm, bellows, corrugated bourdon tube (all used for pressure measurement)

2.5 Displacement or Position sensors

Sensors

A sensor is a device that detects and responds to some type of input from the physical environment. The specific input could be light, heat, motion, moisture, pressure, or any one of a great number of other environmental phenomena.

A displacement sensor is a device used for measuring positional movement or detecting the movement of a given object, these movements can be in either a linear or rotary fashion.

Displacement sensors, also known as position sensors, are a very common type of sensor.

Some of the most common industries for displacement sensors are; Motorsport, automotive, industrial applications, agriculture, aerospace, robotics and many more.

2.6 Velocity, Motion, Force and Pressure

sensors

Velocity sensor

A velocity sensor is a sensor that responds to velocity

The magnet of the velocity sensor is suspended on a membrane (spring) which moves through a coil of wire. Due to the vibration, the coil of wire moves through the magnetic field of the permanent magnet and generates (induces) a voltage signal which is proportional to the vibration (velocity).

Eg. tachometers (employed in a motor to calculate the rotational speed of a shaft), piezoelectric sensor (uses piezoelectric effect to measure changes in velocity)

Motion sensor

A motion sensor is an electronic device that uses a sensor to detect nearby people or objects. Motion sensors are an important component of any security system. When a sensor detects motion, it will send an alert to your security system, and with newer systems, right to your mobile phone.

Active ultrasonic sensors and passive infrared sensors are the two most common motion sensor technologies, both of which are known for their accuracy and reliability.

Active ultrasonic sensors emit ultrasonic sound waves at a frequency above the range of human hearing. These waves bounce off objects in the immediate vicinity and return to the motion sensor.

Passive infrared sensors are a bit more complex than active ultrasonic sensors, but the result is the same.

Infrared motion sensors detect the presence of a person or object by detecting the change in temperature of a given area.

Force sensor

A Force Sensor is defined as a transducer that converts an input mechanical load, weight, tension, compression or pressure into an electrical output signal.

Force Transducers became an essential element in many industries from Automotive (car sensors or vehicle sensors), High precision manufacturing, Aerospace & Defense, Industrial Automation, Medical & Pharmaceuticals and Robotics

Pressure sensor

A pressure sensor is a device or instrument which is able to measure the pressure in gases or liquids.

Pressure sensors can also be used to indirectly measure other variables such as fluid/gas flow, speed, water level, and altitude.

2.7 Temperature and light

Sensors

Temperature sensor

A temperature sensor is a device used to measure temperature.

The sensor is made up of two metals, which generate electrical voltage or resistance once it notices a change in temperature.

Eg. Thermocouple (a sensor made up of two wires with two different metals connected at two points. The voltage between the two wires reflects the change in temperature.)

Light sensor

The light sensor is a device that converts the light energy into an electrical signal output. Light sensors are more commonly known as Photoelectric Devices or Photo Sensors because they convert light energy (photons) into electronic signal (electrons).

Photoelectric sensors use a beam of light to detect the presence or absence of an object.

Unit 3: ACTUATORS-MECHANICAL, ELECTRICAL



Actuators produce physical changes such as linear and angular displacement.

3.1 Mechanical Actuators

Mechanical actuators are devices that transform motion from one form to some other required form,

For e.g. they might transform linear motion into rotational motion, or perhaps a linear reciprocating motion into rotary motion

3.1.1 Machine, Kinematic Link, Kinematic Pair

Machine

It is an apparatus for applying mechanical power, consisting of a number of interrelated parts each having a definite function.

Or

It is a device by means of which available energy can be converted into desired form of useful work.

A Machine is the assembly of resistant bodies whose relative motions are successfully constrained so that available energy can be converted into useful work

Kinematic link

it is a resistant body or an assembly of resistant bodies which make a part or parts of a machine to connect with other parts which have motion 'relative' to it.

A kinematic link is assumed to be completely rigid.

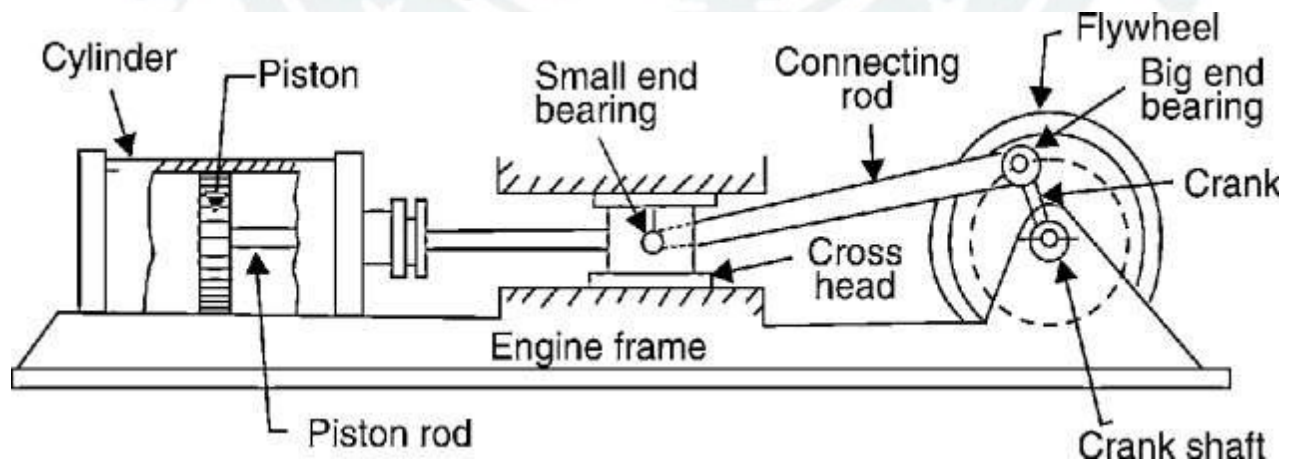

Reciprocating Steam Engine

- Piston, piston rod and cross head ... one link.
- Connecting rod with big and small end bearings ... second link.
- Crankshaft and flywheel ... third link.

- Cylinder, engine frame ... fourth link.



Characteristics of a link.

A link should have two characteristics:

1. It should have relative motion.
2. It must be a resistant body (need not be rigid body).

Types of links:

The various types of links are:

1. **Rigid link**- A link which does not undergo any deformation while transmitting motion is called a "rigid link".
Strictly speaking, rigid links do not exist
2. **Flexible link**- A flexible link in one which is partly deformed in a manner not to the transmission of motion.
Example: Belts, ropes, chains and wires (these link transmit tensile forces only).
3. **Fluid link**- A fluid link is one which is formed by having a fluid in receptacle & the motion is transmitted through the fluid by pressure or compression only
Example: Hydraulic presses, jacks and brakes.

Kinematic Pair

A kinematic pair is a joint of two links that permits relative motion.

The relative motion between the elements or links that form a pair is required to be completely constrained or successfully constrained.

Completely constrained motion-When the motion between a pair is limited to a definite direction irrespective of the direction of force applied, then the motion is said to be a completely constrained motion.

Examples: The motion of a square bar in a square hole and the motion of a shaft with collars at each end are the examples of the completely constrained motion.

The motion of the piston and cylinder, (forming a pair) in a steam engine in which the motion of the piston is limited to a definite direction (i.e., it will only reciprocate) is also an example of completely constrained motion.

Successfully constrained motion-The motion is said to be successfully constrained when the motion between the elements, forming a pair, ---is such that constrained motion is not completed by itself, but by some means.

For e.g. the load is placed on the shaft to prevent axial upward movement of the shaft, then the motion of the pair is said to be successfully constrained.

Classification of kinematic pairs:

1. Classification based on nature of relative motion between the elements:

(i) **Sliding pair**- If two links have a sliding motion relative to each other, they form a sliding pair.

Examples. Piston and cylinder pair, rectangular rod in rectangle hole

(ii) **Turning pair**.-When one link has turning or revolving motion relative to the other, they constitute a turning or revolving pair.

Examples. A shaft rotating in a bearing, Rotation of a crank in a slider crank mechanism is another turning pair.

(iii) **Rolling pair**- When the links of a pair have a rolling motion relative to each other, they form a rolling pair.

Examples. Ball and roller bearings. In a ball bearing, the ball and the shaft constitute one rolling pair whereas the ball

and the bearing is the second rolling pair.



4. **Screw (or helical) pair**-When the two elements of a pair are connected in such a way that one element can turn about the other by screw threads, the pair is known as 'screw pair'.
Example. Nut and bolt arrangement

5. **Spherical pair**-When two elements of a pair are connected in such a way that one element with spherical shape turns about the other fixed element; the pair formed is called a 'spherical pair'.
Examples. The ball and socket joint, attachment of a car mirror

2. Classification based on the nature of contact between elements:

(I) Lower pairs (II) Higher pairs.

(i) **Lower pair**-If a pair in motion has a surface contact between its elements it is called a lower pair.
Eg. shaft rotating in a bearing

(ii) **Higher pair**- In a higher pair there is a line or point contact between the elements of a pair. The contact surfaces of the two elements are not alike or similar.
Examples. toothed gearing, belt and rope drives, cam and follower, ball and roller bearings

3. Classification based on the nature of mechanical constraint:

(i) Closed pairs (ii) Unclosed pairs.

(i) **Closed pairs**-If the elements of the pair, are held together mechanically, they constitute a 'closed pair'.
Examples. All lower pairs.

(ii) **Unclosed pairs**-if the two elements are not held together mechanically, it forms an 'unclosed pair'.
Example. Cam and follower pair

3.1.2 Mechanism, Slider crank Mechanism

Mechanism

When one of the links of a kinematic chain is fixed, the chain is known as mechanism.

Mechanisms are of two types:

Simple mechanism-A mechanism with/our links is known as simple mechanism.

Compound mechanism- The mechanism with more than four links is known as compound mechanism. It may be made by adding two or more simple mechanisms.

Slider crank Mechanism

It consists of one sliding pair and three turning pairs. It is, usually, found in reciprocating steam engine mechanism. This type of mechanism converts rotary motion into reciprocating motion and vice versa

In a single slider crank chain, the links 1 and 2, links 2 and 3 and links 3 and 4 form three turning pairs while links 4 and 1 form a sliding pair'

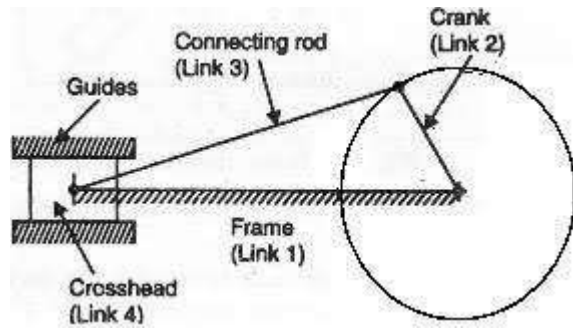

3.1.3 Gear Drive, Spur gear, Bevel gear, Helical gear, worm gear

A gear is a wheel provided with teeth which mesh with the teeth on another wheel, or on to a rack, so as to give a positive transmission of motion from one component to another.

Gears constitute the most commonly used device for power transmission or for changing power-speed ratios in a power system. They are used for transmitting motion and power from one shaft to another when they are not too far apart and when a constant velocity ratio is desired.

GEAR NOMENCLATURE

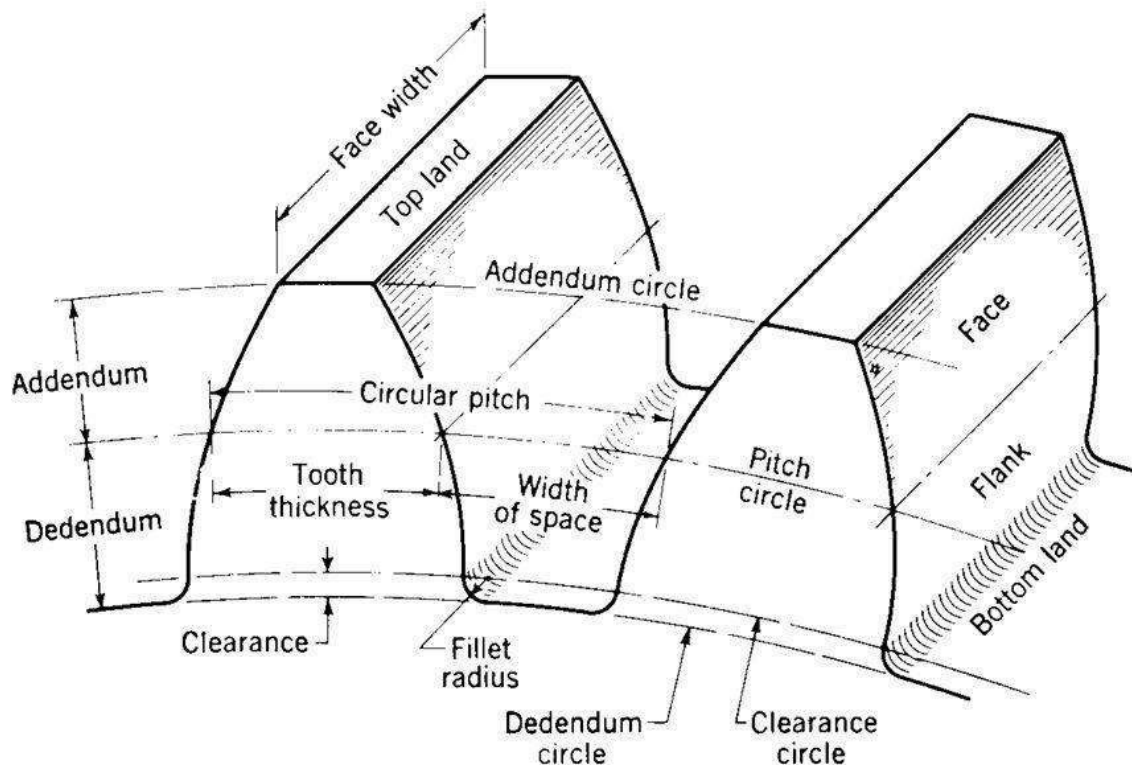

1. **Pitch circle**-It is an imaginary circle which would transmit the same motion as the actual gear, by pure rolling

action.

The diameter of the pitch circle is known as pitch circle diameter.



2. **Addendum circle**- A circle concentric with the pitch circle and bounding the outer ends to the teeth is called an addendum circle.

The diameter of the addendum circle is known as addendum circle diameter.

3. **Addendum**-It is the radial distance between the pitch circle and addendum circle.

4. **Dedendum (Or root) circle**-It is a circle concentric with the pitch circle and bounding the bottom of the tooth.

5. **Dedendum**.-It is the radial distance between the pitch circle and the dedendum circle.

6. **Clearance**. The difference between the dedendum (of one gear) and addendum (of the mating gear) is called as clearance.

7. **Working depth**- It is the sum of the addenda of the two mating gears.

8. **Circular thickness (or Thickness of tooth)**-The length of arc between the sides of a gear tooth, measured on the pitch circle is known as circular thickness (or thickness of tooth).

9. **Tooth space**- It is the width of the space between two adjacent teeth measured along pitch circle.

10. **Backlash**-It is the difference between the tooth space and the tooth thickness.

11. **Face**- It is the action or working surface of the addendum.

12. **Flank**-The working face of the dedendum is called the flank.

13. **Top land**- It is the surface of the top of the tooth.

14. **Bottom land**-It is the surface of the bottom of the tooth space.

15. **Whole depth**-It is the total depth of the tooth space, equal to addendum plus dedendum; also it is equal to the working depth plus clearance

16. **Tooth fillet**- It is the radius which connects the root circle to the tooth profile.

17. **Circular pitch**. The distance measured along the pitch circle from a point on one tooth to the corresponding point on an adjacent tooth is called circular-pitch.

$$p = \pi d / z$$

That is, the circular pitch is calculated by dividing the pitch circle circumference by the number of teeth.

18. **Pitch diameter** -It is the diameter of a pitch circle.

19. **Diametral pitch**. Number of teeth on a wheel per unit of its pitch diameter is called the diametral pitch.

$$\text{diametral_pitch} = \text{Number of teeth on the wheel} / \text{Diameter of the pitch circle}$$

20. **Module**- It is the reverse of the diametral pitch. Ratio between the pitch diameter and the number of teeth is known as module

Types of gears:

The types of gear are discussed below:



1. Spur gear-A spur gear is a gear wheel or pinion for transmitting motion between two parallel shafts. It is the simplest form of geared drive.

The teeth are cast or machined parallel with the axis of rotation of the gear.

The efficiency of power transmission by these gears is very high

The disadvantages are that they are liable to be more noisy in operation and may wear out

2. Helical gear-helical gear is one in which teeth instead, of being parallel with shaft as in ordinary spur gears, are inclined. This ensures smooth action.

3. Bevel gear-A bevel gear transmits motion between two shafts which intersect.

If the shafts are at right angles and wheels equal in size, they are called mitre gears;

If the shafts are not at right angles, they are sometimes called angle bevel gears.

Spiral toothed bevel gears are preferred to straight-toothed bevels in certain applications, because they will run more smoothly and make less noise at high speeds.

4. Worm gear-Worm gears connect two non-parallel, non-intersecting shafts which are usually at right angles. One of the gears is called worm .it is essentially part of a screw meshing with the teeth on a gear wheel, called "worm wheel".

Worm gearing is smooth and quiet.

3.1.4 Belt & Belt drive

A belt is a continuous band of flexible material passing over pulleys to transmit motion from one shaft to another.

Belts are available:

1. with a narrow rectangular cross-section-Flat belts
2. with a trapezoidal cross-section-V-belts
3. Round cross-section-Round belts

Flat belts:

Flat belts are used for their simplicity and because they are subjected to minimum bending stress on the pulleys. The load capacity of flat belts is varied by varying their width, and only one is used in each drive.

They are made of leather, rubber, textile, balata and steel.

V-belts:

A V-belt is a belt of trapezoidal section running on pulleys with grooves cut to match the belt. The normal angle between the sides of the groove is 40 deg.

V-belts are usually made of fabric coated with rubber

They are used when the distance between the shafts is too short for flat-belt drives;

The V-belt is less likely to slip, hence more power can be transmitted for the same belt tension.

Round belts

These are employed to transmit low power, mainly in instruments, machinery of the clothing industry and household appliances.

They may be made of leather and rubber. The diameter range is from 3 to 12 mm, usually from 4 to 8 mm.

Belt drive:

A belt drive consists of the driving and driven pulleys and the belt which is mounted on the pulleys with a certain

amount of tension

Belt drives may be:



- (I) Open belt drive
- (II) Crossed belt drive.

Open belt drives -are applied, between parallel shafts which rotate in the same direction. Here the belt is subject to tension 'and bending.

Crossed belt drives- the power is transmitted between small shafts rotating opposite direction. Since the angle of contact in this type of drive is more, it can transmit more power than open belt drive. However there is more wear and tear of the belt in this drive.

Applications of belt drives:

The main applications of belt drives are:

- (I) To transmit power from low or medium capacity electric motors to operative machines.
- (ii) To transmit power from small prime movers (internal combustion engines) to electric generators, agricultural and other machinery.

3.1.5 Bearings

A bearing is a device which supports, guides and restrains moving elements.

The material used for bearing is commonly cast-iron for slow speeds, bronze or brass lining being fitted for higher steels.

White metal or antifriction metal is used as a lining for the bronze, or it may be held directly in the cast-iron or in the steel of a connecting rod.

Classification of Bearings

Bearings may be classified as follows

1. Plain bearings:
 - (a) Journal bearing.
 - (b)Pivot bearing
 - (c) Collar or thrust bearing.
2. Ball and roller bearings.

Plain bearings

A journal bearing is one in which the bearing pressure is perpendicular to the axis of the shaft. The portion of the rotating element which is in contact with the bearing is called journal.

A pivot bearing is one in which the pressure is parallel to the axis of the shaft and the end of the shaft rests on the bearing surface.

In **collar bearing** the pressure is parallel to the axis of the shaft, which is passed and extended through the bearings. These bearings are employed to take up unbalanced axial loads on the horizontal Shaft

Ball and roller bearings

are also known as rolling contact bearings or rolling element bearings because the bearing elements especially are in a rolling contact.

Sometimes these are also referred to as "antifriction bearings", through some friction is always present owing to rolling resistance between the balls/rollers and contacting parts etc.

The starting friction in ball and roller bearings is lower than that in an equivalent journal bearing in which metal-to-metal rubbing takes place at the time of starting.

The ball and roller bearings are also quite suitable at moderate speeds but at high speeds it is found that a properly designed and lubricated journal bearing has less friction.



3.2 Electrical actuator

An actuator receiving electrical energy for motion is called an electrical actuator.

Designs for electric actuators are based on the specific tasks they accomplish and they can vary in both dimension and size.

Most electric actuators operate through the interaction of magnetic fields and current-carrying conductors to generate force.

Electric actuators are found in applications as diverse as industrial fans, blowers and pumps, machine tools, household appliances.

3.2.1 Switches and relay

Switches

A switch is an electromechanical device used to make or break the circuits.

Switches can be controlled mechanically.

It controls the flow of current by opening or closing of circuits.

They are operated manually by a lever or by pushing the buttons.

It operates slowly when compared to relay because it requires a physical object to make the changes.

Example: Manual control of switch (Physical control of fans & lights at Home)

An electric switch is a device that interrupts the electron flow in a circuit. Circuits consist of a source of power and load. A load is a power-powered device. The function of an electric switch is to regulate the current between the load and source of power. The power source is the electrons that push through the circuits. The voltage is the quantity of force or pressure applied by the power source. Power sources must have a negative and positive endpoint. The negative terminal connects to the charge, and the electrons drive through the circuit. The load receives the current and returns it via the positive terminal to the power source. The electrical switch is inserted in this loop.

Relay

A relay is basically just a switch, but it's a switch operated via remote control.

Relays can be controlled electronically.

It controls high power circuits with low power signals by opening or closing the contacts.

It is used to protect the system from damage.

It operates faster than the switches.

It is a remote control switch.

Example: To turn ON/OFF an Air Conditioner

Relay works on the principle of electromagnetic induction. When the electromagnet is applied with some current it induces a magnetic field around it. In the relay, Copper coil and the iron core acts as an electromagnet.

When the coil is applied with DC current it starts attracting the contact as shown. This is called energizing of relay.

When the supply is removed it retrieves back to the original position. This is called De energizing of relay.



3.2.2 Solenoid

A "solenoid" consists of a coil and a movable iron core called the armature. When the current is passed through the coil it gets energized and consequently the core moves to increase the flux linkage by closing the air gap between the cores. The movable core is usually spring-loaded to allow the core to retract when the current is switched off. The force generated is approximately proportional to the square of the current and inversely proportional to the square of the width of the air gap.

They are frequently used in:

- Home appliances
- Automobiles
- Factory automation.

3.2.3 D.C Motors

A direct current (DC) motor is a type of electric machine that converts electrical energy into mechanical energy. DC motors take electrical power through direct current, and convert this energy into mechanical rotation.

DC motors use magnetic fields that occur from the electrical currents generated, which powers the movement of a rotor fixed within the output shaft. The output torque and speed depends upon both the electrical input and the design of the motor.

DC motors can vary in size and power from small motors in toys and appliances to large mechanisms that power vehicles, pull elevators and hoists, and drive steel rolling mills.

DC motors include two key components: a **stator** and an **armature**. The stator is the stationary part of a motor, while the armature rotates. In a DC motor, the stator provides a rotating magnetic field that drives the armature to rotate.

WORKING

A simple DC motor uses a stationary set of magnets in the stator, and a coil of wire with a current running through it to generate an electromagnetic field aligned with the centre of the coil. One or more windings of insulated wire are wrapped around the core of the motor to concentrate the magnetic field.

The windings of insulated wire are connected to a commutator (a rotary electrical switch), that applies an electrical current to the windings. The commutator allows each armature coil to be energized in turn, creating a steady rotating force (known as torque).

When the coils are turned on and off in sequence, a rotating magnetic field is created that interacts with the differing fields of the stationary magnets in the stator to create torque, which causes it to rotate. These key operating principles of DC motors allow them to convert the electrical energy from direct current into mechanical energy through the rotating movement, which can then be used for the propulsion of objects.

Types of DC Motors

- **Brushless DC motors** are also known as electronically commutated motors, or synchronous DC motors.

The key differences between brushless DC motors and other varieties is that they do not have a commutator, which is replaced by an electronic servomechanism that is able to detect and adjust the angle of the rotor.

The **brushless DC motor** has several advantages. Commutators use soft contacts called 'brushes' which wear down over time. A brushless DC motor is therefore more durable, and also safer than the more classical design.



- The **brushed DC motor** is the original DC motor. The classic brushed motor features a commutator, to reverse the current every half cycle and create single direction torque.

While brushed DC motors remain popular for electrical propulsion, cranes, paper machines, and steel rolling mills, many have been phased out for the more efficient brushless model in recent years.

- A **DC shunt motor** is a variety of brushed motor that has the field windings connected in parallel with the armature. Shunt wound DC motors have a lower current because of the parallel windings.

A shunt motor is used for applications that require a constant torque, where the load is not significantly altered by speed, such as conveyor belts, mixers and hoists.

The specific field windings provide unique shunt motor characteristics that make it such an effective choice for constant torque applications.

Applications of DC motors

At home, small DC motors are used in tools, toys and various household appliances. In retail, the applications of DC motors include conveyors and turntables, while in an industrial setting, large DC motor uses also include braking and reversing applications.

3.2.4 A.C Motors

An AC motor is an electric motor that uses alternating current to produce mechanical energy using magnetism blended with alternating current. The structure of an AC motor includes coils that produce a rotating magnetic field inside a rotor attached to an output shaft, which produces a second magnetic field.

WORKING

The main components of an AC motor are the stator, stationary outer drum, and the rotor, the rotating inner portion attached to the motor shaft. The stator and the rotor produce rotating magnetic fields. The winding of the stator that creates the rotating field is created by alternating current.

In an AC motor the winding serves as the armature and field winding. When the stator is connected to an AC supply flux an air gap is formed rotating the flux at a fixed synchronous speed, which produces voltages in the stator and rotor winding.

The term AC motor describes several versions of the motor, which include single phase, three phase, brake, synchronous, asynchronous, customized, two speed, and three speed single phase. The difference between the various versions relates to the type of work that is required where some forms of AC motors are simple and used for small jobs while other versions are designed for bigger more demanding work. A key difference is the phase of the electrical feed, which is different for residential use compared to industrial use.

Residential electricity is single or double phased while electricity for industrial use is three phased. This distinction is the reason for the difference between industrial AC motors and residential ones.

AC motors are referred to as induction motors since they use electric current to produce torque, which is created by

electromagnetic induction from the magnetic field of the stator



The stator produces a rotating magnetic field. It has a solid metal axle, a loop of wire, coils, squirrel cage, and interconnections. Though a squirrel cage is not found in all AC motors, it is the most common type. In AC motors, electricity is sent directly to the outer coils of the stator. The stator has multiple plates that extend out from its center with copper magnetic wire.

For a three phase AC motor, it has three phase windings with a core and housing. The windings are 120° apart, which can be six or twelve windings. The windings are placed on a laminated iron core.

Unlike a DC motor, the rotor on an AC motor does not have any connection with the external power source. It receives its power from the stator. In a three phase induction motor, the rotor can be a squirrel cage or wound version.

In the squirrel cage version, the rotor consists of rotor bars with end rings at both ends. In the majority of cases, the squirrel cage is made of aluminum or copper. In the operation of a squirrel cage motor, the bars of the rotor interact with the stator's electromagnetic field (EMF). As the current fluctuates, the EMF does the same causing the rotor to rotate producing rotational motion. A key factor in the motion is that the rotor does not turn at the same frequency as the AC current and is constantly trying to catch up, which is how the rotation is produced. If it did have the same frequency, the rotor would freeze, and there would not be any motion.

A wound or slip ring AC motor is a special type of AC motor. It contains the exact same parts as all AC motors but is always three phase. The cylindrical laminated core of the rotor is wound exactly like the windings on the stator with wire. The terminal ends of the wires are connected to slip rings on the output shaft. The slip rings connect to brushes and a variable speed resistor. The slip rings provide control of the speed and torque of the motor, which is the main positive feature of a wound rotor.

Types of AC Motors

Single Phase AC Motor

Single phase AC motors are used where there is a single phase supply. This type of AC motor is smaller and less expensive. They are constructed using fractional kilowatt capacity. The stator is activated by a single phase AC electrical supply. Unlike a three phase AC motor, a single phase motor has one main winding and one auxiliary winding, which is perpendicular to the main winding.

The rotor rotates according to the sum of two oppositely rotating fields, which is the double revolving field theory. The torque that is produced is equal and opposite.

Polyphase AC Motor

Polyphase Motors, or many phase motors, are a type of AC motor that can be two or three phase and are similar to single phase motors in how they operate. The stator poles in a polyphase motor are not aligned with each other, which means that the rotor passes by the stator poles at different times. A polyphase system has a group of equal voltages at the same frequency that are placed to have an equal phase difference between the adjacent electromagnetic fields (EMF). A polyphase system can be two, three, or six phase with the majority being three phase.

Synchronous AC Motor

A synchronous AC motor is where the rotation of the shaft is at the same frequency as the current supply with the rotation period being equal to the integral number of AC cycles. The synchronous speed is constant and at which the motor generates electromotive force.

The speed of a synchronous motor is independent of the load where variations in the load does not affect the speed of the motor. Synchronous motors are not self-starting, which is unlike self-starting motors where the power supply is connected directly to the stator.



Asynchronous Motor

An asynchronous motor uses an induced current in its rotor to produce rotatory motion. This is the most common of the AC motors since it relies on AC current that is connected to the stator for its power supply. All of the power for an asynchronous motor is connected to the stator, none of which is connected to the rotor. The power for the rotor comes from induction.

The induction for the rotor is due to its close proximity to the stator's electromagnetic field, which causes the rotor to generate its own electromagnetic field that causes it to spin. Since there aren't any brushes or slip rings, an asynchronous motor is the most efficient and reliable of all of the AC motors. It is used for heavy duty applications because of its simplicity of design and ruggedness.

3.2.5 Stepper Motors

A stepper motor is an electromechanical device that converts electrical power into mechanical power.

The stepper motor uses the theory of operation for magnets to make the motor shaft turn a precise distance when a pulse of electricity is provided.

The **construction of a stepper motor** is fairly related to a **DC motor**. It includes a permanent magnet like Rotor which is in the middle & it will turn once force acts on it. This rotor is enclosed through a no. of the stator which is wound through a magnetic coil all over it. The stator is arranged near to rotor so that magnetic fields within the stators can control the movement of the rotor.

The stepper motor can be controlled by energizing every stator one by one. So the stator will magnetize & works like an electromagnetic pole which uses repulsive energy on the rotor to move forward. The stator's alternative magnetizing as well as demagnetizing will shift the rotor gradually & allows it to turn through great control.

The **stepper motor working principle** is Electro-Magnetism. It includes a rotor which is made with a permanent magnet whereas a stator is with electromagnets. Once the supply is provided to the winding of the stator then the magnetic field will be developed within the stator. Now rotor in the motor will start to move with the rotating magnetic field of the stator.

In this motor, there is a soft iron that is enclosed through the electromagnetic stators. The poles of the stator as well as the rotor don't depend on the kind of stepper. Once the stators of this motor are energized then the rotor will rotate to line up itself with the stator otherwise turns to have the least gap through the stator. In this way, the stators are activated in a series to revolve the stepper motor.

Types of Stepper Motor

There are three main types of stepper motors, they are:

- Permanent magnet stepper
- Hybrid synchronous stepper
- Variable reluctance stepper

Permanent Magnet Stepper Motor

Permanent magnet motors use a permanent magnet (PM) in the rotor and operate on the attraction or repulsion between the rotor PM and the stator electromagnets.

This is the most common type of stepper motor. This motor includes permanent magnets in the construction of the motor. The main benefit of this stepper motor is less manufacturing cost.



Variable Reluctance Stepper Motor

Variable reluctance (VR) motors have a plain iron rotor and operate based on the principle that minimum reluctance occurs with minimum gap, hence the rotor points are attracted toward the stator magnet poles.

The stepper motor like variable reluctance is the basic type of motor

Hybrid Synchronous Stepper Motor

Hybrid stepper motors are named because they use a combination of permanent magnet (PM) and variable reluctance (VR) techniques to achieve maximum power in small package sizes.

The most popular type of motor is **the hybrid stepper motor** because it gives a good performance. But, this type of stepper motor is expensive as compared with permanent magnet stepper motors.

3.2.6 Specification and control of stepper motors

- Size: 42.3 mm square × 48 mm
- Weight: 350 g
- Shaft diameter: 5 mm
- Steps per revolution: 200
- Current rating: 1.2 A per coil
- Voltage rating: 4 V
- Resistance: 3.3 Ω per coil
- Holding torque: 3.2 kg-cm
- Inductance: 2.8 mH per coil
- Lead length: 30 cm
- Output shaft supported by two ball bearings

Stepper motor control provides this input train of pulses to command the motor to move to the desired position or at the desired speed.

Stepper motor control constant voltage drives are used to apply a constant positive or negative voltage to each winding to drive motion.

3.2.7 Servo Motors D.C & A.C

A **servo motor** is a type of motor that can rotate with great precision. Normally this type of motor consists of a control circuit that provides feedback on the current position of the motor shaft, this feedback allows the servo motors to rotate with great precision. If you want to rotate an object at some specific angles or distance, then you use a servo motor. It is just made up of a simple motor which runs through a **servo mechanism**.

If motor is powered by a DC power supply then it is called DC servo motor, and if it is AC-powered motor then it is

called AC servo motor.



Servo Motor Working Mechanism

It consists of three parts:

1. Controlled device
2. Output sensor
3. Feedback system

It is a closed-loop system where it uses a positive feedback system to control motion and the final position of the shaft. Here the device is controlled by a feedback signal generated by comparing output signal and reference input signal.

Here reference input signal is compared to the reference output signal and the third signal is produced by the feedback system. And this third signal acts as an input signal to the control the device. This signal is present as long as the feedback signal is generated or there is a difference between the reference input signal and reference output signal. So the main task of servomechanism is to maintain the output of a system at the desired value at presence of noises.

A servo consists of a Motor (DC or AC), a potentiometer, gear assembly, and a controlling circuit. First of all, we use gear assembly to reduce RPM and to increase torque of the motor. Say at initial position of servo motor shaft, the position of the potentiometer knob is such that there is no electrical signal generated at the output port of the potentiometer. Now an electrical signal is given to another input terminal of the error detector amplifier. Now the difference between these two signals, one comes from the potentiometer and another comes from other sources, will be processed in a feedback mechanism and output will be provided in terms of error signal. This error signal acts as the input for motor and motor starts rotating. Now motor shaft is connected with the potentiometer and as the motor rotates so the potentiometer and it will generate a signal. So as the potentiometer's angular position changes, its output feedback signal changes. After sometime the position of potentiometer reaches at a position that the output of potentiometer is same as external signal provided. At this condition, there will be no output signal from the amplifier to the motor input as there is no difference between external applied signal and the signal generated at potentiometer, and in this situation motor stops rotating.

Difference between AC Servo Motor and DC Servo Motor

Characteristics	AC Servo Motor	DC Servo Motor
Efficiency	Low (about 5-20%)	High
Speed & Torque	Adaptable to strong torque and high-speed working condition.	Adaptable to a limited torque and speed.
Stability	Less stability issues	More problems of stability
Noise	No radio frequency noise	Brushes cause radio frequency noise
Operation	Have stable and smooth operation	Noisy operation
Weight & Size	Lighter weight and small in size	Heavy weight and large in size
Repair & Maintenance	Since no commutators, Less maintenance is required	Because of commutation process, regular maintenance is needed.
Output Power	Deliver low power normally between 0.5W and 100W	Provide high power

Unit 4: PROGRAMMABLE LOGIC CONTROLLERS (PLC)

4.1 Introduction

A PLC is an industrial computer that has been adapted for the control of manufacturing processes, such as assembly lines, machines, robotic devices, or any activity that requires high reliability, ease of programming, and process fault diagnosis.

4.2 Advantages

PLC increases the reliability, flexibility, and accuracy of the automation system.

PLC has a lower cost associated with it as compared to the other automation technology.

PLC has good capabilities and flexibility for programming. Even, you can easily make the modification in the existing program at any time.

Programming used for PLC is easy to write and understand.

PLC does not take much space. It occurs smaller in size, especially compact PLC.

Fast operation

PLC has low maintenance associated with it.

In the PLC system, we require less and simple wiring as compare to the other systems.

One can easily make the changes in an already implemented design.

In the case of PLC design, if anything goes wrong, one can easily troubleshoot the problem.

It can sustain in a robust environment with less maintenance.

4.3 Selection and uses of PLC

Uses

1. Industrial Applications of PLC-

Transportation System likes Conveyor Belt System.

Packing and Labeling System in Food & Beverage.

Automatic Bottle or Liquid Filling System.

Packaging and Labelling System in Pharma Industries.

Industrial Crane Control System for Operation of Overhead Traveling Crane.

Glass Industries for glass production and recording data.

Paper Industries for the production of Pages, Books or Newspapers, etc.

Cement Industries for manufacturing or mixing the right quality and quantities of raw materials, and accuracy of data regarding.

Fault Detection and Protection of Industrial Machines

2. Power Station Applications of PLC-

PLC is used to Monitor and Detect fault conditions.

It is used in the Power Generation, Transmission, and Distribution System.

PLC used in Underground Coal Mine or Water Level Sensing and Data Survey.

3. Commercial Applications of PLC-

Smart Traffic Control Signal System.

Fire Detection and Alarm System.

Luggage Handling System.

Sequence or Numerical Counting and Packing System.

Mining Equipment Line Detection

Selection of a PLC

For selection of a PLC, the following criteria need to be considered:

1. Types of inputs/outputs required
2. Input/Output capacity required.
3. Size of memory required.
4. Speed and power required for CPU

4.4 Basic Internal Structures

The main components of a PLC consist of a central processing unit (CPU), power supply, programming device, and input and output (I/O) modules.

CPU

The CPU is the brain of the PLC and carries out programmed operations. These operations or outputs are executed based on signals and data provided from connected inputs.

I/O Modules

PLC input modules connect various external devices, such as sensors, switches, and push buttons to the PLC to read various digital and analog parameters, such as temperature, pressure, flow, speed, etc.

Output modules convert signals from the CPU into digital or analog values to control output devices.

PLC Programming Language

The most common methods of PLC programming include Ladder Logic, Function Block, and structured text.

Ladder Logic

Ladder Logic is a graphical PLC programming language and is the most common method of programming. Ladder Logic can be used to execute tasks such as sequencing, counting, timing, data manipulation, and more.

For the Ladder Diagram (LD) programming language, normally open and normally closed contact is used in the form of input. And the coil or lamp is used in the form of output.

The symbolic representation of I and O modules in the LD program.

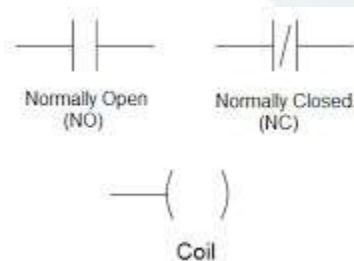

Structured Text

Structured text is a text-based PLC programming. Programming with structured text has multiple advantages, such as the program requiring less space due to being text based instead of graphic based.

Function Block

Function block PLC programs are represented in the form of graphical blocks. Function blocks can have standard functions such as timers, counters, calculating min and max values, obtaining averages, and more.

4.5 Input/Output Processing & Programming

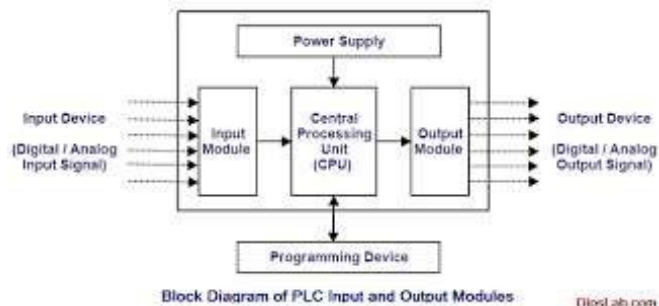

The input device provides a signal to an input module. This input module is connected with the CPU for the initial automated processes. CPU processes all the input data.

After processing by CPU, it gives output data to the output module. The output module provides a signal to the output device.

And the main function of the programming device is to change or monitor the PLC programming.

Classification of PLC Input and Output Modules

The classification of input and output (I/O) modules of PLC is based on the types of signals.

1. Digital I/O Module

The digital module is also called Discrete Module.

In this module, the I/O signal work on the binary system i.e. only 0 or 1 value.

It is useful in the ON or OFF condition.

2. Analog I/O Module

The analog module is called a Continuous Module.

This analog signal provides any intermittent value between the two extreme limits (initial to final range) for the analog input module.

4.6 Mnemonics

Mnemonics are memory devices that help learners recall larger pieces of information, especially in the form of lists like characteristics, steps, stages, parts, etc.

Mnemonic code provides the same information as ladder diagram and can be typed directly on Programming Console.

There are a lot of instructions used to develop the PLC program. Each instruction has a respective function.

LD - LOAD Instruction

These instructions are used to start a line of the program.

It is used in the first contacts in the normally open condition (NO).

LD NOT - LOAD NOT Instruction

These instructions are used to start a line of the program.

It is used in the first contacts in the normally closed condition (NC).

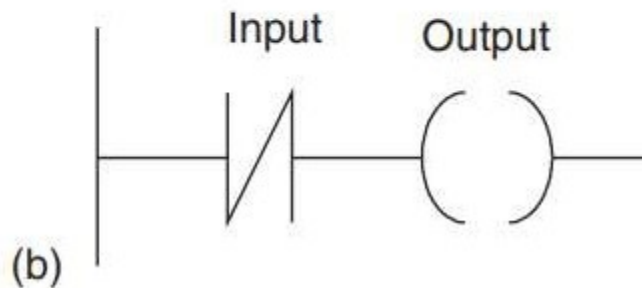
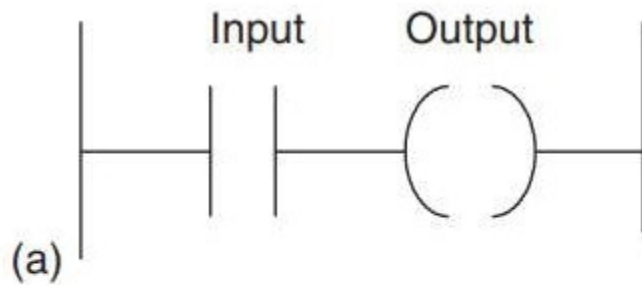

AND - AND Instruction

These instructions are used in the second contact in a normally open (NO) and a series with previous contacts

AND NOT - AND NOT Instruction

These instructions are used in the second contact in a normally closed (NC) and in series with previous contacts

OR - OR Instruction

These instructions are used in the second contact in a normally open (NO) and in line (parallel) with previous contacts.

OR NOT - OR NOT Instruction

These instructions are used in the second contact in a normally closed (NC) and in line (parallel) with previous contacts

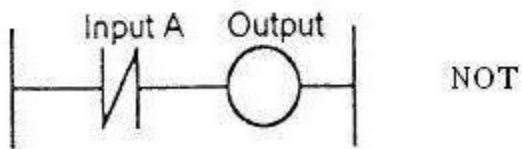
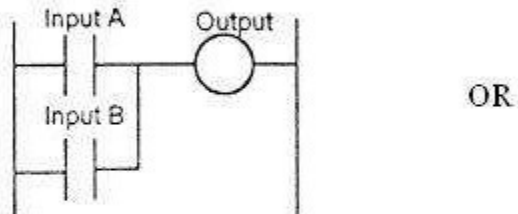
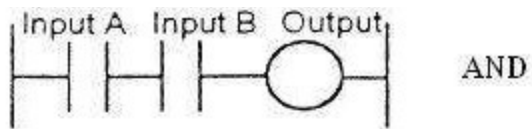

plcmanual.com

OUT - OUTPUT Instruction

These instructions are used for the coil output.

END

END instruction has no physical contact device.
It is the last instruction required for completion of a program.
If no END instruction, the program cannot be implemented

4.7 Master and Jump Controllers

Master controls can be thought of as "emergency stop switches".

PLC manufacturers offer a form of a master control relay as part of their instruction set. These instructions function in a similar manner to the hardwired master control relay; that is, when the instruction is true, the circuit functions normally, and when the instruction is false, non-retentive outputs are switched off.

Jump instruction in ladder logic is used to skip some process or rungs according to the requirement

When the jump instruction is used, the PLC will not execute the instructions of a rung that is jumped

The MCR instruction sets all non-retentive outputs to the false state and keeps the retentive outputs in their last state. The JMP instruction leaves all outputs in their last state.

Unit 5: ELEMENTS OF CNC MACHINES

5.1.1 NC machines

Numerical control, popularly known as the NC is very commonly used in the machine tools.

The numerical control machine is defined as the machine that is controlled by the set of instructions called as the program.

In numerical control method the numbers form the basic program instructions for different types of jobs; hence the name numerical control is given to this type of programming.

When the type of job changes, the program instructions of the job also change.

It is easier to write the new instructions for each job, hence NC provides lots of flexibility in its use.

The NC technology can be applied to wide variety of operations like drafting, assembly, inspection, sheet metal working, etc. But it is more prominently used for various metal machining processes like turning, drilling, milling, shaping etc.

Due to NC all the machining operations can be performed at the fast rate resulting in bulk manufacturing becoming quite cheaper.

There are 3 types of NC machines and are as follows.

- **Traditional Numerical Control (NC Machine)**

They can run with the help of a tape reader system i.e. whatever the operation you want to perform, you can punch it on the tape, and thereby the NC machine can perform that operation.

- **Computer Numerical Control (CNC Machine)**

The Evolution of the CNC machine takes place after the evolution of NC machines. To overcome the limitation of the NC machine, the CNC machine has come into the picture.

In the case of NC machines, the Tape Reader system is used, which after several usages, the wear and tear of the tape take place and the operator has to punch again on the new tape to carry out the operation.

In order to avoid this limitation of NC Machine, the CNC machine uses a computer-generated file to store the program which was written by the usage of G-Codes and M-Codes.

Whatever operation you need to change like speed, feed, depth of cut, etc. can be changed in the program instantly and there is no damage to the file as of tape reader. This is the reason, CNC machines are used which are highly accurate compared to NC Machines.

- **Distributed Numerical Control (DNC Machine)**

The DNC Machine is similar to CNC Machine, except a remote computer is used to control no. of machines that can perform no. of operations at a time

A NC Machine is consist by following parts:

1. MCU or CPU
2. Drive Unit
3. Feedback Devices
4. Tape Reader system
5. Very Few Manual Controls

MCU (Memory Controlled Unit):

MCU is the Memory Control Unit that is taking the information from the input devices via the keyboard or mouse and analyze the data, and send the data to the output devices available in the NC machine.

Drive Unit:

Drive unit is a device that is used for converting Electrical energy into Mechanical energy which is required for traveling the axis.

Feedback Devices:

Feedback device is a Displacement Measuring Equipment. MCU will compare the distance traveled by the axis with the distance to be traveled and determines the difference in distance.

The MCU will calculate the no.of pulses and send it to the drive unit. This process continues in the form of a cycle. Feedback Device→MCU→Drive Unit.

Tape Reader System:

The instructions for doing operation was punched on the paper tape. For reading the instruction given in the punched paper tape, a **tape reader system** will be used.

Light is provided on one side of the tape and light receiving sensors are placed on the other side.

When the tape is moving and stopping at some location where the holes are present, the light is passing and is incident on light receiving sensors. The sensors which are receiving the light generate the electrical pulse and that is to be sent to the Memory Control Unit (MCU) to drive the motor of a machine to do the operation precisely.

Very Few Manual Controls:

Even though the above parts are present in the NC machine, still the manual interventions are required for loading and unloading of the work piece, switching ON and OFF, etc. called manual controls.

5.1.2 CNC machines

Computer Numerical Control (CNC) machining is a manufacturing process in which pre-programmed computer software dictates the movement of factory tools and machinery. The process can be used to control a range of complex machinery, from grinders and lathes to mills

With a numerical control machine, programs are inputted via punch cards. By contrast, the programs for CNC machines are fed to computers through small keyboards. CNC programming is retained in a computer's memory. The code itself is written and edited by programmers.

The language behind CNC machining is alternately referred to as G-code, and it's written to control the various behaviors of a corresponding machine, such as the speed, feed rate and coordination.

Functions of CNC:

The principal functions of CNC are:

1. Machine tool control.
2. In-process compensation.
3. Improved programming and operating features.
4. Diagnostics.

Advantages of CNC machines:

CNC machines offer the following advantages in manufacturing:

1. Greater flexibility.
2. Reduced data reading error.
3. Increased productivity.

4. Consistent quality.
5. Automatic material handling.
6. Elimination of operator errors.
7. Reduced operator activity.
8. Lower labour cost.
9. Smaller batches.
10. Longer tool life.
11. Just-in-time manufacture.
12. Reliable operation.
13. Elimination of special jigs and fixtures.
14. Reduced inspection.
15. Less scrap.
16. Accurate costing and scheduling.
17. CNC machine can diagnose program and can detect the machining malfunctioning even before the part is produced.
18. Conversion of units - possible within computer memory.

Disadvantages of CNC machines:

1. Higher investment cost.
2. Higher maintenance cost.
3. Costlier CNC personnel.
4. Air-conditioned places are required for the installation of the machines.
5. Unsuitable for long run applications.
6. Planned support facilities.

Applications of CNC:

CNC is being used in the following machines/areas:

- Drilling machines.
- Turning machines.
- Boring machines.
- Milling machines.
- Grinding machines.
- Pipe bending machines.
- Coil winding machines.
- Flame cutting machines.
- Welding, wire cut EDM and several other areas.

5.1.3 CAD/CAM

CAD/CAM (Computer-Aided Design/Computer-Aided Manufacture) technology was initiated in the aerospace industry but presently it is spreading at a rapid pace in all industries.

It can be defined most simply as the use of computers to translate a product's specific requirements into the final physical product.

With this system, a product is designed, produced and inspected in one automatic process.

It plays a key role in areas such as design analysis, production planning, detailing, documentation, N/C part programming, tooling fabrication, assembly, jig and fixture design, quality control, and testing.

Whenever any deviation is noted, a programmable controller takes automatic corrective action to compensate for the deviation. Thus a closed loop system is formed which produces consistent quality products, reduces wastes and increases productivity.

CAD/CAM system is ideally suited for designing and manufacturing mechanical components of free form complex with three dimensional shapes

5.1.3.1 CAD

CAD (Computer Aided Design) is defined as:

A design process using sophisticated computer graphics techniques, backed up with computer software packages to aid in the analytical, development, costing and ergonomic problems associated with design work

Advantages:

The following are advantages of CAD:

1. Drawings can be produced at a faster rate.
2. Drawings produced by CAD systems are more accurate and neat.
3. In this system there is no repetition of the drawings.
4. CAD systems assimilate several special draughting techniques which are not available with conventional means.
5. Design calculations and analysis can be carried out quickly.
6. With CAD systems superior design forms can be produced.
7. CAD simulation and analysis techniques can drastically cut the time and money spent on prototype testing and development - often the costliest stage in the design process.
8. Using CAD systems design can be integrated with other disciplines.

5.1.3.2 CAM

CAM (Computer-Aided Manufacture) concerns any automatic manufacturing process which controlled by computers.

The most important elements of CAM are:

1. CNC manufacturing and programming techniques.
2. Computer controlled robotics manufacture and assembly.
3. Flexible Manufacturing Systems
4. Computer Aided Inspection (CAI)
5. Computer Aided Testing (CAT)

Advantages:

CAM entails the following, advantages '.

1. Product obtained is superior in quality.
2. The manufactured form has a greater versatility.
3. Higher production rates with lower work-forces.
4. There is less likelihood of human error.
5. Increased manufacturing efficiency
6. The production processes can be repeated via storage of data.

5.1.3.3 Software and hardware for CAD/CAM

Software usually consists of a number of separate application packages to perform the desired function. The size of computer depends on the number and sizes of packages and number of work stations

Hardware is responsible for the reliability and speed of response of the system.

CADD Hardware

- System Unit
- Central Processing Unit (CPU)
- Memory
- Hard Disk, Floppy Disk, CD-ROM

- External Storage Devices
- The Monitor
- Printers and Plotters
- Digitizer, Puck and Mouse

CADD Software

- Draw
- Edit
- Data output
- System control
- Data storage and management

5.1.3.4 Functioning of cad cam systems

In order to generate the actual model, **CAM works alongside CAD**—using CAD designs, CAM uses numerical coding to run the machine that creates the product. A CAD/CAM package allows companies to develop and save their own product designs, and program machines to create the actual component.

Computer-aided design & computer-aided manufacturing (CAD/CAM) software is **used to design and manufacture prototypes, finished products, and production runs of products.**

5.1.3.5 Features and characteristics of CAD/CAM system

1. A major portion of the output of the engineering sector involves batch production and CAD/CAM offers immense cost and quality benefits for such requirements.
2. The work-in-progress, in batch production, is reduced considerably.
3. It is possible to produce at random all the variants and series of a product planned to be manufactured by a firm.
4. Such a system has inherent flexibility to cater to new models of the product in pipeline without major modification.
5. In such a system, several machining centres are arranged one after the other with robots and proper automatic materials handling equipment. Software is developed to integrate the machine CNC control and the handling system. Each machining centre is equipped with several tool magazines. All the tools required to complete each operation on each model of the product can be stored in the magazine.
6. All the part Programs for the different models are stored in the memory. System has only to identify the model of the product presented to a machine in order to complete the machining operations. Thus it is possible to have totally random mixes of models of a product proceeding down the line at any one time.
7. System can be conceived in multiplies of 15-20 minutes operations. If certain operations take longer, then multiples of similar machines can be installed in the line. Sometimes identical machines are introduced for each operation so that production can continue even if one machine goes down.

5.1.3.5 Application areas for CAD/CAM

1. Design and design analysis:

CAD system would be best suited for drawing offices where frequent modifications are required on drawing and several parts repeat.

It must be remembered that it is very easy with computer to make modifications and very fast to draw part profile once its details are fed into computer.

Once a drawing is entered in the CAD system, later modifications can be done quickly, and detail drawings can be prepared quickly from a general arrangement drawing.

Storing of the drawing is very convenient, easy, occupies very less space and symbols for electrical, hydraulic, control and instrumentation circuits can be called up quickly and positioned on the schematic drawing.

Standard components can be stored permanently in the data base and called up and positioned on the drawing, resulting in saving of time and enforcement of standards. It is possible to associate nongraphical information like part number, supplier, material etc., for any component assembly.

It is very convenient to calculate properties like weight, centre of gravity, moment of inertia, etc., because 3-D models can be easily produced.

It is also possible to carry out finite element analysis by producing meshing for analysis.

2. Manufacture:

With CAD/CAM system the complete NC part programming process can be carried out interactively,

5.2 Elements of CNC machines

1. Machine structure.
2. Guideways/Slideways.
3. Drives.
4. Spindle and spindle bearings.
5. Measuring systems.
6. Controls.
7. Gauging
8. Tool monitoring.
9. Swarf removal.
10. Safety.

Measuring Systems-

Measuring systems are used on all the CNC machines to perform the following functions:

1. To monitor the position of a slide on a slideway.
2. To orient the spindle/table.
3. To measure the spindle speed.

Controls

For CNC machines, CNC controls are of significant importance. Earlier, CNC controls were developed for simple applications in turning, machining centres and grinding, but these days CNC systems have been developed to meet with the increased machine tools requirements of higher spindle speeds, higher rapid traverses and more number of axes. The new generation computer numerical controls allow simultaneous control of more axes, interpolate positions faster, and use more data points for precise control.

The new controllers offer the following:

- Advanced graphic interfaces;
- Program simulation;
- Some cutter selecting capabilities.

Gauging

The quality can be maintained by eliminating the effect of parameter like tool wear and thermal growth, with the use of automatic gauging system.

The gauging on a machine tool may be used for the following purposes-

To inspect workpiece.

To detect tool breakage.

To define tool offsets.

To automatically align the workpiece.

To detect the stock variation

Tool Monitoring System

The tools wear out or even break during machining. If tool wear and breakage is not properly monitored, the productivity of the machine and the quality of the component produced are affected. Now-a-days established monitoring sensors and systems are available commercially which can be integrated with CNC machines.

Following are the two ways of monitoring tool wear and breakage:

1. Direct monitoring: In this type of monitoring a touch probe is directly used to monitor the tool condition by checking the tool edge position and checking for the existence of a tool edge.

2. Indirect monitoring: Here, the tool condition is checked indirectly by monitoring the change in certain parameter whose value when affected reflects the tool condition.

Following parameters are used to monitor tool condition:

(i) Cutting forces.

(ii) Tool life.

(iii) Workpiece dimensions.

(iv) Emission of noise during cutting

(v) Power of the spindle or a feed drive or a driven tool.

Swarf Removal

In CNC machines the cutting time is much more and as such the volume of swarf generated is also more.

- Unless the swarf is quickly and efficiently removed from the cutting zone, it can affect the cutting process and quality of the finished product.

- Also the swarf cannot be allowed to accumulate at the machine tool because it may hamper the access to the machine tool.

- In addition some auxiliary functions like automatic component loading or automatic tool change may also be affected by accumulation of swarf.

To overcome all above problems it is necessary to provide an efficient swarf control system with the CNC machine tools with some mechanism to remove the swarf from the cutter and cutting zone and for the disposal of swarf from the machine tool area itself.

Safety

As the CNC machines are under continuous automatic operation, there is a need to protect the machine guideways and to ensure operators safety since the machines run at high speeds with automatic auxiliary operations.

- In order to have efficient working and long life of the machine it is essential to protect machine guideways, drive screws and transducers etc. These elements are protected by the use of various types of collapsible guards and covers.

All the sliding elements are fitted with wipers and drive screws are normally protected by using telescopic covers. Jets of cutting fluids are used to wash away swarf and clear the tool work area.

- Operator's safety is very important aspect which cannot be overlooked. To ensure safe working conditions the CNC machine tools are provided with metallic or plastic guards.

5.2.1 Introduction

5.2.2 Machine Structure

The "machine structure" is the load carrying and supporting member of the machine tool.

The design and construction of CNC machine should be such that it meets the main "objectives"

- (i) High precision and repeatability
- (ii) reliability;
- (iii) Efficiency.

In order to meet these requirements, the numerically controlled machine tools should have a structure with the following characteristics:

1. It does not deform or vibrate beyond the permissible limits under the action of static and dynamic forces, to which it is subjected.

Static load of a machine tool results from the weights of slides and the workpiece, and the forces due to cutting.

Dynamic loads a term used for the constantly changing forces acting on the structure while the movement is taking place.

These forces cause the whole machine to vibrate and the origin of these vibrations may be due to unbalanced rotating parts, improper meshing of gears, bearings irregularities

2. Its design should be such that the thermal distortion is minimum. The machine tool should be protected from external and internal heat sources; some of these heat sources are: Electric motor; friction in mechanical drives, gear boxes, bearings and guideways; machinery Process; temperature of surrounding objects.

3. The machine structure design should be such that the removal of swarf is easy and the chips etc., do not fall on the slideways.

5.2.3 Guideways/Slide ways

5.2.3.1 Introduction and Types of Guideways

Introduction

In machine tools the guideways are used to serve the following purposes;

- (i) To control the direction or line of action of the carriage or the table on which a tool or a workpiece is held.
- (ii) To absorb all static and dynamic loads.

The guideways may be an integral part of the machine structure or may be mounted separately on the structure.

These guideways may be horizontal, vertical or inclined.

However vertical and inclined guideways are preferred so that chips produced during the cutting operation do not get collected on the quickways.

The shape and size of the work produced depends on the accuracy of the movement

Guideways are broadly classified as follows:

1. Friction guideways.

(i) Vee guideways.

(ii) Flat guideways

(iii) Dovetail guideways.

(iv) Cylindrical guideways

2. Antifriction linear motion (LM) guideways.

3. Frictionless guideways:
(i) Hydrostatic guideways.
(ii) Aerostatic guideways.

Friction guideways

These guideways find wide application in conventional machine tools due to their low manufacturing cost and good damping properties.

It operate under conditions of sliding friction and do not have a constant coefficient of friction. The frictional coefficient varies with the sliding velocity

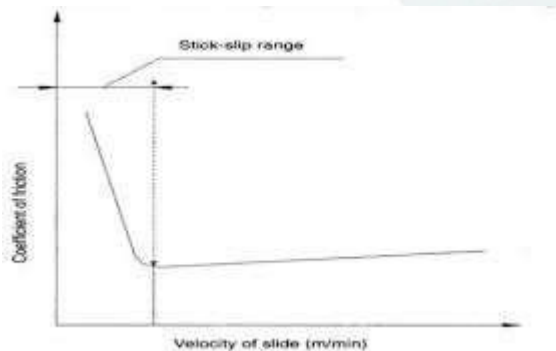

At the commencement of the movement, the coefficient of friction is very high, but as the velocity increases it falls rapidly and beyond a certain critical velocity it remains almost constant. Thus, to start motion/movement, the force to overcome friction has to be correspondingly high. This phenomenon is known as, stick-slip phenomenon.

Vee guideways:

The Vee guideways are widely used on machine tools, especially ' on lathe beds.

These guideways wear away rapidly due to lack of bearing surface. These are difficult to manufacture.

Flat guideways

These guideways have better load bearing capabilities than other guideways.

- These are easier to manufacture.
- In such guideways the chip accumulation and lubrication problems are serious.
- These do not wear uniformly.
- Jibs are used to ensure accurate fitting of the slide on the flat surface.

Dovetail guideways

These guideways have large load carrying capacity and tend to check the overturning tendency under eccentric loading.

- They are preferred when both horizontal and vertical locations of moving parts are considered essential.
- Jibs are used to ensure accurate fitting of the slide on the dovetail surface. The jibs are tapered and can be adjusted to reduce excessive clearance caused by wear.

Cylindrical guideways

These guideways are aery efficient for relatively short traverses and light loads.

- Their use for long traverses and heavy loads is not suitable because the guideways may sag or bend in the centre of the span under a load.

Antifriction linear motion (LM) guideways

These guideways are used on CNC machine tools to reduce amount of wear, friction, heat generation and improve smoothness of the movement,

The antifriction guideways are employed to overcome the relatively high coefficient of friction in metal-to-metal contacts. .

They use rolling elements in between the moving and stationary elements of the machine.

Advantages: The antifriction guideways claim the following advantages over the friction guides:

1. High load carrying capacity.
2. Heavier preloading possibility.
3. High traverse speeds.
4. Low frictional resistance.
5. No stick-slip.
6. Ease of assembly.
7. Commercially available in ready-to-fit condition.

Their main disadvantage is 'lower damping capacity'.

Types of antifriction guideways

1. Linear bearing with balls uses recirculating balls within a bush type of bearing.

These are designed to run along precision ground shafts and offer frictionless movement making strokes of length with high linear precision.

2. Linear bearing with rollers:

The recirculating linear roller bearings are used for movement along a flat plane. Their main characteristic feature is that there is continuous roller circulation which allows unlimited linear movement.

Frictionless guideways

Hydrostatic guideways:

- In these guideways the surface of the slide is separated from the guideway by a very thin film of fluid supplied at pressures as high as 300 bar.
- In hydrostatic guideways frictional wear and stick slip are entirely eliminated.
- In such guideways a high degree of dynamic stiffness and damping is obtained, both the characteristics contributing to good machining capabilities.
- Owing to high cost and difficulty in assembly, their application is limited.

Aerostatic guideways:

In these guideways, the slide is raised in a cushion of compressed air which entirely separates the slide and guideway surfaces.

Advantages of frictionless guideways:

1. Longer life.
2. Large damping capability.
3. Frictionless.
4. High stiffness.
5. No stick-slip.
6. Less thermal distortion due to better heat dissipation.

Disadvantages:

1. Difficulty in assembling the guideways.
2. High cost.

3. Leakage problems.

5.2.3.2 Factors of design of guideways

- (i) Reduce friction;
- (ii) Reduce wear;
- (iii) Satisfy the requirements of movement of the slides;
- (iv) Improve smoothness of the drive

The following factors should be considered while designing guideways:

1. Geometric and kinematic accuracy.
2. Position in relation to work area.
3. Provision for adjustment of play.
4. Rigidity.
5. Damping capability.
6. Velocity slide.
7. Friction characteristics.
8. Wear resistance.
9. Protection against swarf and damage.
10. Protective guards to safeguard the guideways against accidental damages.
11. Freedom from unnecessary restraints.
12. Effective lubrication and efficient lubrication systems.

5.2.4 Drives

Devices which impart motion to mechanical components

The primary function of the drive is to cause motion of the controlled machine tool member to conform as closely as possible to the motion commands issued by the CNC system.

5.2.4.1 Spindle drives

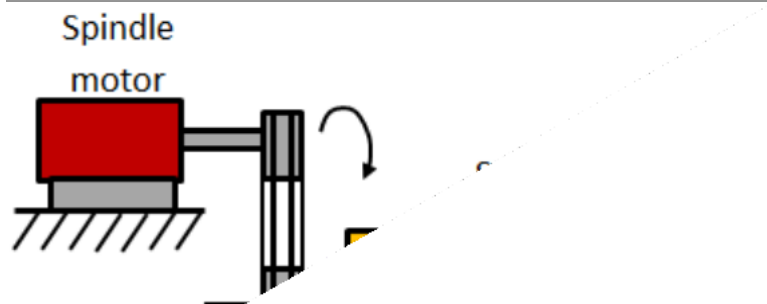

The spindle drives are used to provide angular motion to the workpiece or a cutting tool.

These drives are essentially required to maintain the speed accurately within a power band which will enable machining of a variety of materials with variations in material hardness. The speed ranges can be from 10 to 20,000 rpm.

The machine tools mostly employ DC spindle drives. High overload capacity is also needed for unintended overloads on the spindle due to an inappropriate feed. It is desirable to have a compact drive with highly smooth operation.

5.2.4.2 Feed drive

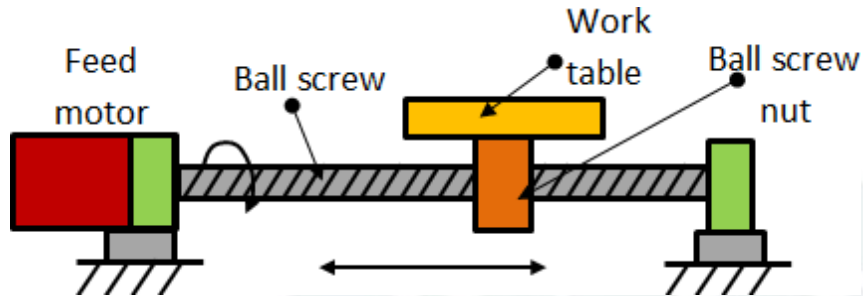

These are used to drive the slide or a table

The requirements of an ideal feed drive are as follows.

- The feed motor needs to operate with constant torque characteristics to overcome friction and working forces.
- The drive speed should be extremely variable with a speed range of about 1: 20000, which means it should have a maximum speed of around 2000 rpm and at a minimum speed of 0.1 rpm.
- The feed motor must run smoothly.
- The drive should have extremely small positioning resolution.

5.2.5 Spindle and Spindle Bearings

Spindle

The spindle carrying the workpiece or tool when subjected to high cutting speeds and high material removal rates, experiences deflection and thrust forces. To ensure increased stability and minimize torsional strain, the machine spindle is designed to be short and stiff & the final drive to the spindles is located near to the front bearing as possible.

The rotational accuracy of the spindle is dependent on the quality and design of bearings used. The ball or roller are suitable for high speeds and high loads because of low friction, low wear rate & lesser liability to incorrect adjustment and ease of replacement when necessary.

Spindle bearings

In modern machine tools, which employ high performance cutting tool materials, the designed characteristics of spindles used are:

- (i) Minimum deflection under varying loads.
- (ii) Long service life.
- (iii) Stiffness.
- (iv) Thermal stability'.
- (v) Good running accuracy both in radial and axial directions.
- (vi) Axial load carrying capacity'.
- (vii) High speed of operation,

The various types of spindle bearings used in the design of a spindle for machine tools are:

1. Antifriction bearings.
2. Hydrostatic bearings.
3. Hydrodynamic bearings

1. Antifriction bearings

The antifriction bearings are suitable for high speeds and high loads.

These are often preferred to hydrodynamic bearings because the following reasons-

High reliability.

Ease of replacement.

Low friction.

Moderate dimensions.

Lesser liability to suffer from wear or incorrect adjustment.

2. Hydrostatic bearings

Here the spindle is supported by a relatively thick film of oil (called hydrostatic pockets) supplied under pressure; the oil in the pockets being stationary. The oil is supplied to the bearing through a throttling system to control pressure and volume. Lubricating seals are used to prevent the leakage of oil. There is no mechanical contact.

- The load carrying capacity of this type of bearing is independent of the speed of rotation.

They have the following merits '.

(i) High wear resistance.

(ii) High damping properties.

(iii) High running accuracy.

These bearings are used in grinding and boring machines etc.

3. Hydrodynamic bearings

The Pressure of oil within the bearing is created by the rotation of the spindle. As the spindle rotates, the oil in contact with the spindle is carried into wedge shaped cavities between the spindle and the bearing due to centrifugal action. As the oil is forced through the small clearances between the bearing and spindle, the oil Pressure is increased.

In this type of bearing there is a constant flow of oil round the spindle, maintaining a thick oil film.

The essential features Of these bearings are:

(i) Good running accuracy.

(ii) Simplicity.

(iii) Good damping Properties.

(iii) Good damping Properties.

The main limitation of this type of bearing is that a definite clearance must be provided for the oil film to be maintained between bearing and the spindle; the clearances normally provided vary from 50 μm to 200 μm depending upon the journal diameter'

These bearings are used where the load carrying capacities are low-and frequent starting and stopping of the spindle is not required as in the case of grinding machines

Unit 6: ROBOTICS

6.1 Definition, Function and laws of robotics

DEFINITION

Robotics is an interdisciplinary branch of computer science and engineering. Robotics involves design, construction, operation, and use of robots. The goal of robotics is to design machines that can help and assist humans.

FUNCTION

Functions of Robot

- Classified into three categories:
- "Sensing" the environment by external sensor
E.g.- Vision, touch, voice, proximity etc.
- "Decision making" based upon information received from sensors
- "Performing" the task decided

LAWS OF ROBOTICS

Isaac Asimov's "Three Laws of Robotics"

1. A robot may not injure a human being or, through inaction, allow a human being to come to harm.
2. A robot must obey orders given it by human beings except where such orders would conflict with the First Law.
3. A robot must protect its own existence as long as such protection does not conflict with the First or Second Law.

6.2 TYPES OF INDUSTRIAL ROBOTS

1. Cartesian Robots

Cartesian robots, which are also called linear robots or gantry robots, are industrial robots that work on three linear axes that use the Cartesian Coordinate system (X, Y, and Z), meaning they move in straight lines on 3-axis (up and down, in and out, and side to side).

Cartesian robots are a popular choice due to being highly flexible in their configurations, giving users the ability to adjust the robot's speed, precision, stroke length, and size.

Cartesian Robots are one of the most commonly used robot types for industrial applications and are often used for CNC machines and 3D printing.

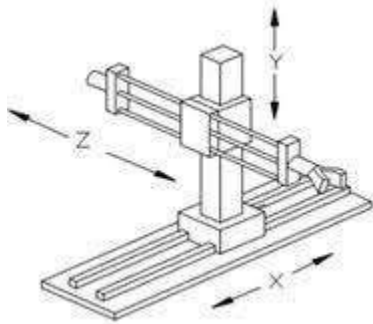

2. SCARA Robots

SCARA stands for Selective Compliance Assembly Robot Arm or Selective Compliance Articulated Robot Arm.

SCARA Robots function on 3-axis (X, Y, and Z), and have a rotary motion as well.

SCARA Robots excel in lateral movements and are commonly faster moving and have easier integration than Cartesian Robots.

Typically, SCARA robots are used for assembly as well as bio-med application.



3. Articulated Robots

Articulated Robots mechanical movement and configuration closely resembles a human arm.

The arm is mounted to a base with a twisting joint.

The arm itself can feature anywhere from two rotary joints up to ten rotary joints which act as axes, with each additional joint or axis allowing for a greater degree of motion.

Most Articulated Robots utilize four or six-axis.

Typical applications for Articulated Robots are assembly, arc welding, material handling and packaging.



4. Cylindrical Robots

Cylindrical Robots have a rotary joint at the base and a prismatic joint to connect the links.

The robots have a cylindrical-shaped work envelop, which is achieved with rotating shaft and an extendable arm that moves in a vertical and sliding motion.

Cylindrical Robots are often used in tight workspaces for simple assembly, coating applications due to their compact design.

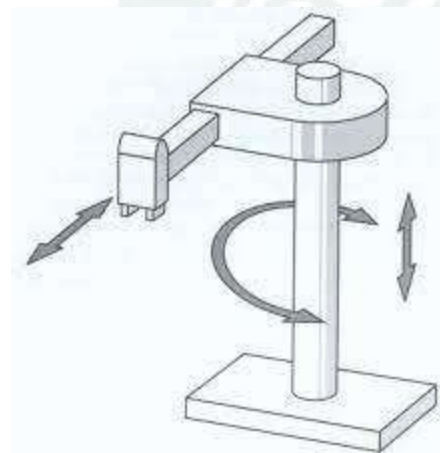

5. Delta Robots

Delta Robots, or parallel robots, possess three arms connected to a single base, which is mounted above the workspace.

Delta Robots work in a dome-shape and can move both delicately and precisely at high speeds due to each joint of the end effector being directly controlled by all three arms.

Delta Robots are often used for fast pick and place applications in the food, pharmaceutical, and electronic industries.



6. Polar Robots

Polar Robots, or spherical robots, have an arm with two rotary joints and one linear joint connected to a base with a twisting joint.

The axes of the robot work together to form a polar coordinate, which allows the robot to have a spherical work envelope.

Polar Robots are credited as one of the first types of industrial robots to ever be developed.

Polar robots are commonly used for die casting, welding, and material handling.

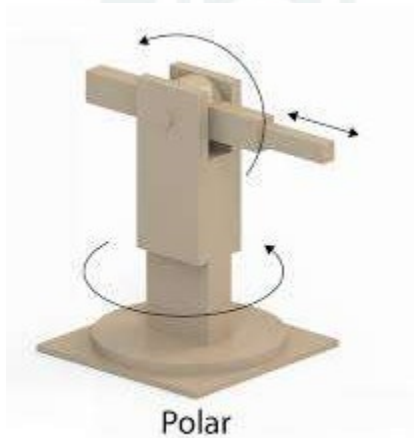

7. Collaborative Robots

Collaborative Robots or Cobots are robots that can directly and safely interact with humans in a shared workspace.

Cobots are typically used for pick and place, quality inspection, etc.



6.3 ROBOTIC SYSTEMS

There are three types of robotic systems –

1. Manipulation robotic system

The manipulation robot system is the most commonly used in the manufacturing industry.

These systems are made up of many of the robot arms with 4-6 axes and varying degrees of freedom.

They can perform several different functions, including welding, material handling and material removal applications.

2. Mobile robotic system

The mobile robotic system is a bit different.

This system consists of an automated platform that moves items from one place to another.

While these robot systems are used heavily in manufacturing for carrying tools and spare parts, they are also used in the agricultural industry for transporting products.

3. Data acquisition and control robotic system

Data acquisition and control robotic systems are used to gather, process and transmit data for a variety of signals.

They are also used in software for engineering and business.

Many of the mobile robotic systems can use signals from these systems.

6.4 ADVANTAGES AND DISADVANTAGES OF ROBOTS

Advantages

- Robots can increase productivity, efficiency, quality and consistency of products.
- Unlike humans, robots don't get bored
- Until they wear out, they can do the same thing again and again
- They can be very accurate
- Robots can work in environments which are unsafe for humans
- Robots don't have the same environmental requirements that humans do
- Robots have some sensors/actuators which are more capable than humans

Disadvantages

- The use of robots can create economic problems if they replace human jobs
- Robots can only do what they are told to do – they can't improvise
- Safety procedures are needed to protect humans and other robots
- Although robots can be superior to humans in some ways but they don't have such powerful brains, and cannot compete with a human's ability to understand.
- Often robots are very costly – in terms of the initial cost, maintenance, the need for extra components and the need to be programmed to do the task.

